

NORTH DAKOTA GEOLOGICAL SURVEY

WILSON M. LAIRD, *State Geologist*

BULLETIN 47

NORTH DAKOTA STATE
WATER CONSERVATION COMMISSION

MILO W. HOISVEEN, *State Engineer*

COUNTY GROUND WATER STUDIES 8

**GEOLOGY and GROUND WATER
RESOURCES**

of

CASS COUNTY, NORTH DAKOTA

PART I

GEOLOGY

By

ROBERT L. KLAUSING

Geological Survey

United States Department of the Interior



Prepared by the United States Geological Survey in co-
operation with the North Dakota State Water Commission,
North Dakota Geological Survey, and Cass County
Board of Commissioners.

GRAND FORKS, NORTH DAKOTA

1968

CONTENTS

This is one of a series of county reports published cooperatively by the North Dakota Geological Survey and the North Dakota State Water Conservation Commission. The reports are in three parts; Part I describes the geology, Part II represents ground water basic data, and Part III describes the ground water resources. Part III will be published later and will be distributed as soon as possible.

	Page
ABSTRACT-----	v
INTRODUCTION -----	2
Purpose of study-----	2
Fieldwork and acknowledgments-----	2
Previous work-----	3
Well-numbering system-----	4
GEOGRAPHY-----	4
Location and general features-----	4
Physiography and topography-----	4
Drainage-----	7
Soils and land use-----	8
Climate-----	8
PRE-PLEISTOCENE GEOLOGY-----	8
Stratigraphy of pre-Pleistocene rocks-----	8
Precambrian crystalline rocks-----	11
Paleozoic rocks-----	11
Winnipeg Formation-----	11
Cretaceous rocks-----	11
Dakota Sandstone-----	12
Graneros Shale-----	12
Greenhorn Formation-----	13
Topography of the bedrock surface-----	13
Pre-Pleistocene history-----	13
PLEISTOCENE GEOLOGY-----	14
Subsurface units-----	15
Older till-----	15
Buried outwash-----	15
Buried stratified drift, undifferentiated-----	18
Buried lake deposits-----	18

	Page
Drift of late Wisconsin age	19
Till and associated stratified drift	19
Till	19
Ground moraine	20
Washboard moraine	20
Kettle chain	21
Stratified drift	21
Kames	21
Eskers	21
Maple River deposits and associated terraces	22
Ice-marginal outwash channels and associated deposits	26
Lake Agassiz deposits	28
Sheyenne delta	28
Maple delta	29
Shore deposits	29
Herman beach	30
Norcross and Tintah beaches	31
Campbell beach	31
Lower beaches	31
Lake-plain deposits	31
Silt unit	32
Clay unit	32
Maple and Sheyenne ridges	33
Intersecting minor ridges	33
RECENT DEPOSITS	34
Alluvium	34
Dune sand	35
PLEISTOCENE AND RECENT HISTORY	35
SELECTED REFERENCES	37

ILLUSTRATIONS

Plate	1. Bedrock contour map	(in pocket)
	2. Geologic sections	(in pocket)
	3. Surficial geologic map	(in pocket)
		Page
Figure	1. Map of North Dakota showing location of county ground-water studies	1
	2. Diagram showing system of numbering wells, springs, and test holes	5
	3. Map showing physiographic divisions and drainage	6
	4. Map showing general soil types	9
	5. Map showing approximate location of buried outwash bodies	16
	6. Photograph of exposed buried outwash	17
	7. Photograph of undifferentiated stratified drift	18
	8. Photograph showing washboard moraines	20
	9. Photograph of kame	22
	10. Photograph showing poorly bedded sand and gravel in esker	23
	11. Photograph showing stratification of sand and gravel in esker	23
	12. Photograph showing lower terrace remnant	24

	Page
13. Graph showing distribution of particles in terrace remnant-----	25
14. Photograph showing bedding in terrace deposit -----	26
15. Photograph of typical beach deposit-----	30

TABLES

Table 1. Stratigraphic sequence and lithologic characteristics of bedrock units -----	10
---	----

GEOLOGY AND GROUND WATER RESOURCES of Cass County, North Dakota

Part I - Geology

by Robert L. Klausung

ABSTRACT

Cass County comprises an area of 1,749 square miles in the southeastern corner of North Dakota. About one-fourth of the county is in the Drift Prairie physiographic province; the rest is in the Red River Valley (Lake Agassiz basin) physiographic division.

The major stratigraphic units are, in ascending order: crystalline rocks of Precambrian age; Winnipeg Formation of Ordovician age; and Dakota Sandstone, Graneros Shale, and Greenhorn Formation of Cretaceous age. No indurated rocks younger than the Greenhorn are known to be present in the county.

Pleistocene glacial drift covers the entire county. The known thickness of the drift, including the Lake Agassiz deposits, ranges from 132 to 447 feet. All the surficial features of the county are late Pleistocene in age. Drift, probably deposited by more than one ice sheet, is present in the subsurface, but older drift can be differentiated in only a few places. Local zones of oxidized till, extensive bodies of buried outwash, and buried lake clays are valid indications of older drift in the subsurface.

The major surficial features in the county are the ice-marginal drainage channels and the channel of the proglacial Maple River. Minor features include kames, eskers, terraces in the proglacial Maple River channel, ground moraine, and local recessional features referred to as washboard moraines. The trends of the washboard moraines show, at least in part, the configuration of the ice margin at the time they were formed.

The flatness of the Red River Valley is interrupted by the escarpment of the Sheyenne delta and the beaches of glacial Lake Agassiz. The Sheyenne delta covers an area of about 60 square miles in the south-central part of the county. It consists of sand and silt as much as 120 feet thick. The lake-floor deposits include two distinct lithologies; the upper unit is mainly silt and the lower unit is mainly plastic clay.

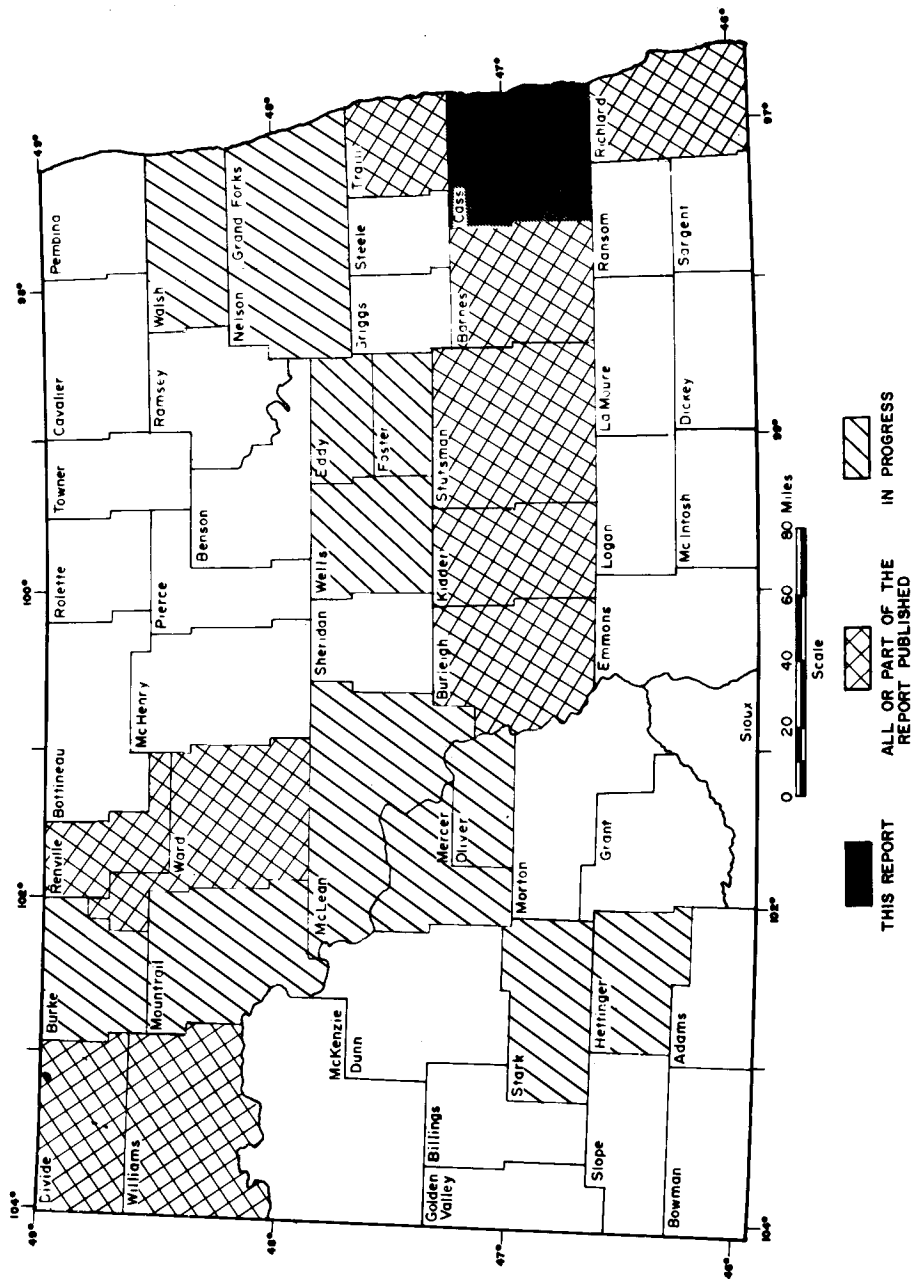

FIGURE 1. County ground-water studies in North Dakota.

INTRODUCTION

This is the first of three reports describing the results of a study of the geology and ground-water resources of Cass County (fig. 1). The study was made during the period 1962-66 by the U.S. Geological Survey in cooperation with the North Dakota State Water Commission and the North Dakota Geological Survey. The initial request for the study was made by the Cass County Board of Commissioners.

The second report "Geology and Ground Water Resources of Cass County, North Dakota, Part II, Ground Water Basic Data." is a compilation of the data collected during the study (Klausing, 1966). The third report "Geology and Ground Water Resources of Cass County, North Dakota, Part III, Ground Water Resources," is an evaluation of the ground-water resources of the county and will be published later.

Purpose of study

The primary purpose of the study was to determine the occurrence, availability, and quality of ground water in Cass County. This report describes the geology of the county to the extent necessary to provide a framework for the discussion of the ground-water resources.

Fieldwork and acknowledgments

The surficial geology of the county was mapped by the author during the field seasons of 1964 and 1965. Field data were plotted on topographic quadrangle maps (scale 1:24,000) where available, and on aerial photographs (scale 1:20,000) in areas not covered by topographic maps. The data were later transferred to a base map (scale 1:63,360), which had been compiled from the North Dakota State Highway Department general highway maps of Cass County.

Subsurface data were obtained mainly from 92 test holes drilled during the field seasons of 1963, 1964, and 1965. The test holes were drilled by the North Dakota State Water Commission, Frederickson's Inc., and Lako Drilling Co. The test holes were logged by personnel of the North Dakota State Water Commission and the U.S. Geological Survey. The data collected during 1963-65 were supplemented with test-hole data collected during previous ground-water

studies and with logs of wells and test holes provided by other State and Federal agencies and by private firms. The logs of most of these test holes were given by Byers and others (1946), Dennis and others (1949), Dennis and others (1950), Brookhart and Powell (1961), and Klausung (1966) and are not repeated in this report.

The following companies and agencies were particularly helpful in supplying data and material: Frederickson's Inc., Lako Drilling Co., U.S. Soil Conservation Service, U.S. Bureau of Reclamation, North Dakota State Highway Department, and the Cass County Road Department.

Previous work

The glacial deposits in Cass County were described first by Warren Upham in 1895. He gave a detailed description of the beach and deltaic deposits laid down in glacial Lake Agassiz; he also described certain aspects of the morainal terrain bordering the former lake basin.

In 1905, C.M. Hall and D.E. Willard described the geology of the Casselton and Fargo quadrangles (scale 1:125,000), and in 1909, D.E. Willard described the geology of the Tower quadrangle (scale 1:125,000). Willard's map shows some of the morainal tracts and outwash channels in southwestern Cass County that are described in this report.

Simpson (1929) gave a general summary of the geology and hydrology of Cass County in his report on the ground-water resources of North Dakota.

Leverett (1912, 1932) mapped the southern end and outlet of the Lake Agassiz basin, and described the geology in the extreme southern and western parts of Cass County.

Byers and others (1946) summarized the geology in the Fargo area in a report on ground water in the Fargo-Moorhead area, North Dakota and Minnesota.

Dennis and others (1949) described the geology and ground water resources of Cass and Clay Counties, North Dakota and Minnesota.

Dennis and others (1950) described the geology of the Kindred area in a report on ground water in the Kindred area, Cass and Richland Counties, N. Dak.

Horberg (1951), Colton (1958), and Clayton and others (1965) described and presented differing theories regarding the occurrence of intersecting low ridges on the plain of glacial Lake Agassiz.

Brookhart and Powell (1961) described the geology and ground-water resources in the vicinity of Hunter, N. Dak.

Cass County is included in the map by Colton and others (1963), which shows the general glacial features of North Dakota.

Well-numbering system

The wells, springs, and test holes in the county are numbered according to a system based on the location in the public land classification of the U.S. Bureau of Land Management. It is illustrated in figure 2. The first numeral denotes the township north of a base line, the second numeral denotes the range west of the fifth principal meridian, and the third numeral denotes the section in which the well is located. The letters a, b, c, and d designate, respectively, the northeast, northwest, southwest, and southeast quarter sections, quarter-quarter sections, and quarter-quarter-quarter sections (10-acre tract). For example, well 138-50-15daa is in the NE1/4NE1/4SE1/4 sec. 15, T. 138 N., R. 50 W. Consecutive terminal numerals are added if more than one well is recorded with a 10-acre tract.

GEOGRAPHY

Location and general features

Cass County is in the southeastern part of North Dakota and has an area of 1,749 square miles. In 1960, the population of the county was 66,947. Fargo, the largest city in North Dakota, had a population of 46,662, and South West Fargo had a population of 3,328. The next largest city is Casselton, with a population of 1,394. There are 15 communities in the county having populations of less than 600. The area is served by the Northern Pacific and Great Northern Railways, both of which have main lines and numerous trunk lines crossing the county. Two Federal highways provide access to the area. U.S. Highway 81 crosses from north to south along the eastern edge of the county. U.S. Interstate Highway 94 crosses the county from east to west. State and county highways that are paved or gravel surfaced generally are accessible throughout the year.

Physiography and topography

Cass County is in the western lake section of the Central Lowland physiographic province of Fenneman (1938, p. 559), and occupies parts of the Drift Prairie and Red River Valley divisions, as described by Simpson (1929, p. 4-7) (fig. 3).

About 480 square miles in the western part of the county is in the Drift Prairie. This area is a youthful glaciated plain, which is interrupted only by minor glacial

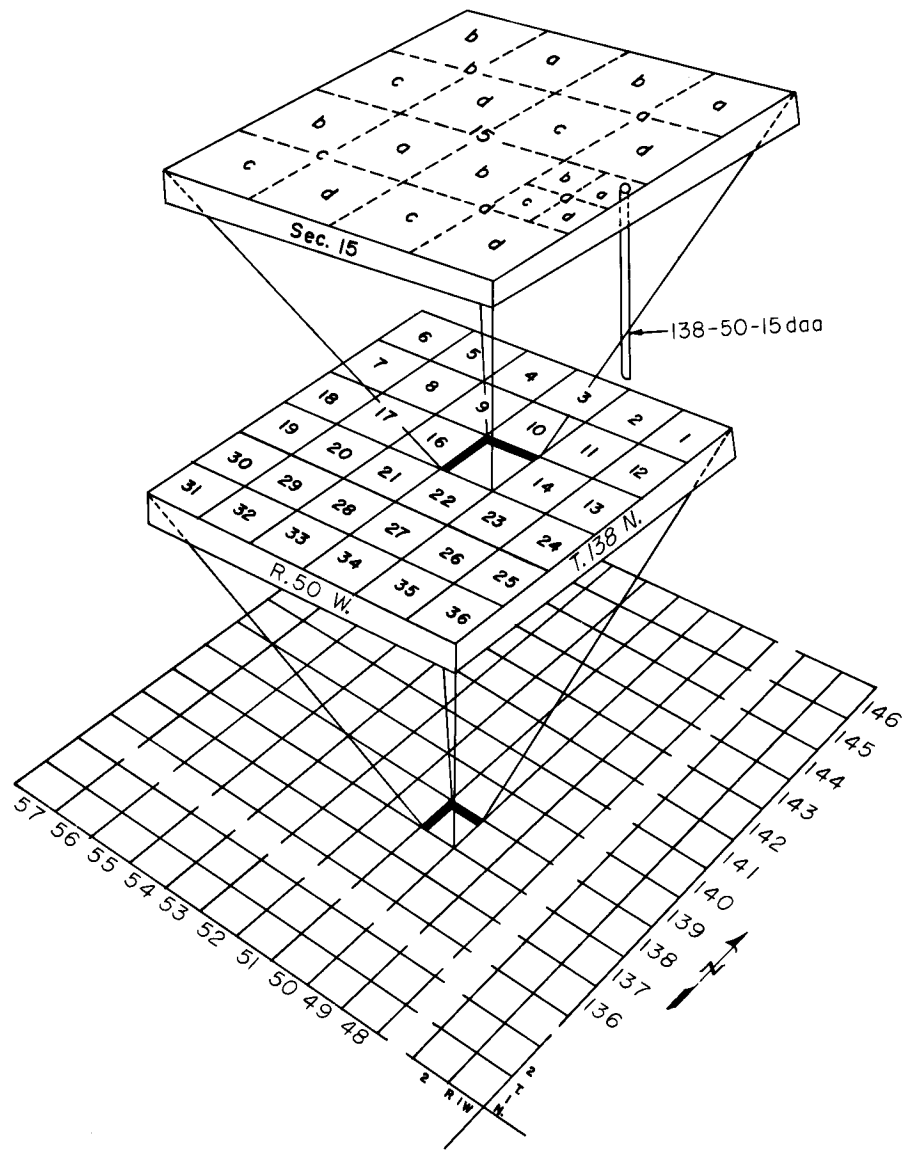

FIGURE 2. System of numbering wells, springs, and test holes.

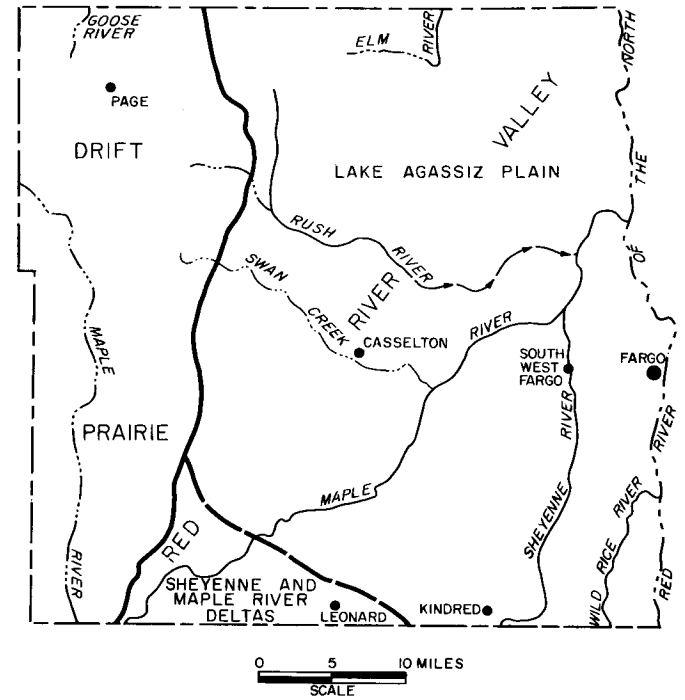

FIGURE 3. Physiographic divisions and drainage.

landforms and stream valleys. The land surface varies from strongly rolling to nearly flat. Local relief generally ranges from 10 to 20 feet per mile, but in some areas it may be as much as 40 feet.

The Red River Valley area can be divided into two units: (1) the Sheyenne and Maple River deltas, which together occupy an area of about 70 square miles; and (2) the flat, nearly featureless plain once occupied by glacial Lake Agassiz.

Northeast of Leonard, the Sheyenne delta rises 75 to 100 feet above the lake plain. To the west, it merges with the Maple River delta and the shore deposits of glacial Lake Agassiz. The surface of the Sheyenne delta in Cass County is relatively flat, and the local relief usually does not exceed 5 feet. Relief on the Maple River delta ranges from 5 feet per mile to 20 feet per mile. The Maple River crosses the delta in a northeasterly direction through a valley that ranges from a quarter of a mile to three-quarters of a mile wide and is as much as 50 feet deep.

The Lake Agassiz plain is a flat, nearly featureless plain that has a northward slope of about 1-1/2 feet per mile and an eastward slope that ranges from 2 feet per mile near the Red River to 20 feet per mile farther west. The most prominent relief features of the lake plain are the north-south trending beaches that lie along

the western edge of the plain, and a few isolated ridges in the eastern part of the plain. These features rarely exceed 15 feet of height and generally range from 5 to 10 feet in height. The Red River of the North and its tributaries are entrenched 15 to 30 feet into the plain. Except in the vicinities of the beaches, isolated ridges, and stream valleys, local relief is generally less than 5 feet.

Drainage

The Red River of the North, which flows north along the east edge of the county, is the major stream in the area (fig. 3). Natural drainage in the lake plain is not well integrated, and a large part of the runoff is through manmade drains. The Elm River heads in the northern part of the county and drains northward. Swan Creek flows southeastward across the lake plain and empties into the Maple River a few miles southeast of Casselton. The Rush River heads in the NE cor. T. 143 N., R. 53 W., and flows south for a distance of about 13 miles before turning in a southeasterly direction. About 6 miles southeast of Amenia, the channel disappears. During periods of runoff, water flowing down the Rush River is channeled into the Sheyenne River through a manmade drain. The Wild Rice River enters the county near the southeastern corner and flows in a northeasterly direction for a distance of about 10 miles before entering the Red River of the North. The Sheyenne River, which enters the county about 1 mile southeast of Kindred, flows northward for about 30 miles before emptying into the Red River of the North, north of Fargo.

Drainage in the Sheyenne and Maple deltas is largely subsurface. The surficial drainage pattern is poorly developed because the soils and underlying deposits are highly permeable. The Maple delta is drained in part by the Maple River, which flows in a northeasterly direction across the delta. Surficial drainage in the Sheyenne delta consists of a few short, deep gullies in the northeast-facing slope of the delta. These gullies carry runoff only during periods of heavy rainfall and (or) snow melting.

Drainage in the Drift Prairie is mostly interior. Numerous small depressions collect runoff during periods of melting snow and heavy rainfall. The Drift Prairie is also drained by the Maple River, Swan Creek, and the south branch of the Goose River. The Maple River flows from north to south through the western part of the county. It leaves Cass County at the southern edge of sec. 34, T. 137 N., R. 55 W. and then reenters the county about 3 miles to the east. From this point, the river flows northeasterly across the Maple delta and the lake plain before emptying into the Sheyenne River about 3 miles north of South West Fargo.

Soils and land use

Most of the soils in Cass County are characterized by a thick black organic topsoil and limey subsoil. Omodt and others (1961) divided the soils of Cass County into the following general types: Barnes-Hamerly clay loam, Barnes-Svea clay loam, Glyndon-Gardena loam, Embden-Ulen sandy loam, Hecla-Hamar sandy loam, Fargo clay, Bearden clay, and Hamerly-Svea-Tetonka clay loam (fig. 4). The Fargo clay is the dominant soil type, and, along with the Bearden clay, it covers the greater part of the lake plain. The Glyndon-Gardena loam and the Embden-Ulen sandy loam cover an area that roughly corresponds to the zone of littoral deposits bordering the lake plain on the west. The Hecla-Hamar sandy loam covers most of the area occupied by the Sheyenne-Maple River deltas. The Barnes-Hamerly, Barnes-Svea, and Hamerly-Svea-Tetonka clay loams cover most of the Drift Prairie.

Most of Cass County is cultivated; however, portions of the county lying in the Sheyenne delta are used only for grazing because the light sandy soils are subject to wind erosion when tilled. Parts of the Drift Prairie, also, are used mainly for grazing because they have considerable relief and are subject to erosion by water.

Climate

The climate of the area is characterized by long, cold winters and short summers. During the winter, temperatures as low as 35° F below zero have been recorded. The summers are usually warm, and midday temperatures occasionally rise to 100° F. However, the average maximums are in the 80's. The mean annual temperature is 39.9 degrees. Mean annual precipitation for the period 1939 through 1963 was 19.30 inches; most of the precipitation falls between May and September.

PRE-PLEISTOCENE GEOLOGY

Stratigraphy of pre-Pleistocene rocks

Cass County is covered with a thick mantle of glacial drift and no outcrops of pre-Pleistocene rocks exist in the county. Information obtained from well logs and test holes indicates that no rocks of Tertiary age are present. In most parts

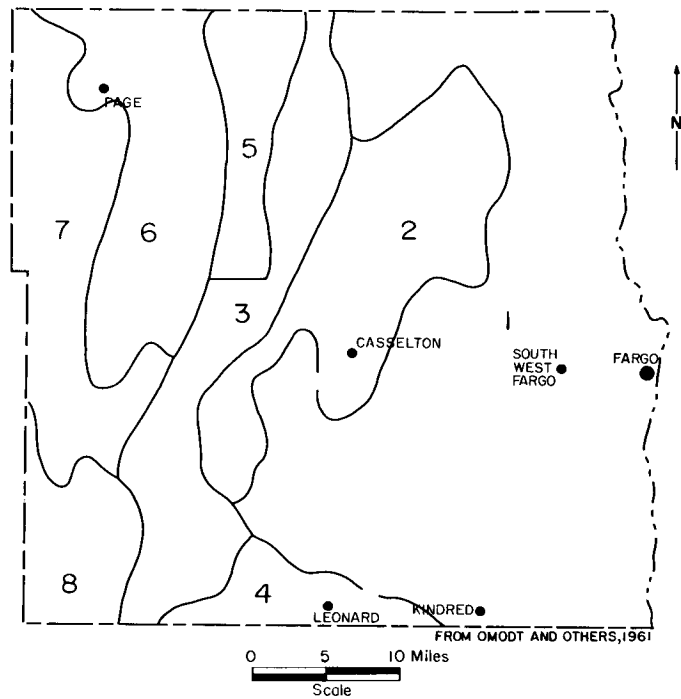

EXPLANATION

- | | |
|-----------------------------|-------------------------------------|
| 1
FARGO CLAY | 5
EMBDEN-ULEN SANDY CLAY |
| 2
BEARDEN CLAY LOAM | 6
BARNES-SVEA CLAY LOAM |
| 3
GLYNDON-GARDENA LOAM | 7
HAMERLY-SVEA-TETONKA CLAY LOAM |
| 4
HECLA-HAMAR SANDY LOAM | 8
BARNES-HAMERLY CLAY LOAM |

FIGURE 4. General soil types.

of the county, the pre-Pleistocene rocks immediately below the glacial drift are of Cretaceous age. The Cretaceous rocks generally rest on Precambrian rocks; however, in the northwestern part of the county, they may overlie Paleozoic rocks. The stratigraphic relations of the bedrock units and the overlying drift are shown in table 1.

TABLE 1. Stratigraphic sequence and lithologic characteristics of bedrock units.

(U.S. Geological Survey nomenclature)

Era	System	Formation	Description	Thickness	
Cenozoic	Quaternary	Recent	Alluvium	Silt and clay on flood plains of modern streams.	0-15
		Pleistocene	Glacial drift	Glacial till, glaciofluvial deposits, and glacial lake deposits.	132-447
Mesozoic	Cretaceous	Greenhorn Formation	Shale, grayish-black, calcareous; thin beds of limestone, abundant white specks and shell fragments.	0-110	
		Graneros Shale	Shale, dark-greenish-gray to black, noncalcareous; interbedded silt and fine sand, commonly laminated, carbonaceous.	0-157	
		Dakota Sandstone	Sandstone, mostly fine-grained with interbedded black shale and silt, some carbonaceous material.	0-143	
Paleozoic	Ordovician	Winnipeg Formation	Greenish-gray shale with a thin basal sandstone.	0-200	
Precambrian		Undifferentiated crystalline rocks	"Granite," dark-green to red on fresh surface; weathered granite commonly consists of red, green, or white clay.	Unknown	

PRECAMBRIAN CRYSTALLINE ROCKS

The crystalline rocks underlying Cass County are referred to the Precambrian and commonly are termed "granite." Very little is known about the composition of these rocks because drilling is generally stopped when hard rock is reached. Because Precambrian granite crops out in southwestern Minnesota, it is assumed that the crystalline rocks underlying Cass County are also of granitic composition.

In the eastern part of the county, the depth to the crystalline rocks ranges from 132 to 300 feet. In the central and south-central parts, they are from 400 to 600 feet below land surface. No test holes or wells are known to have reached the Precambrian in the western part of the county. However, wells tapping Cretaceous aquifers at depths of as much as 900 feet below land surface indicate that the Precambrian rocks lie below this depth.

In most places, the upper part of the Precambrian rocks consists of varicolored clay that is generally referred to as "weathered granite." This material commonly contains granitic fragments and angular quartz grains, and is believed to be the weathered residuum of granitic rocks that were exposed to prolonged subaerial erosion.

In most of the area, the Precambrian rocks are overlain by Cretaceous rocks; however, locally the Cretaceous rocks are absent and the Precambrian is overlain directly by glacial deposits. The maximum thickness of Precambrian rocks penetrated by test drilling is 243 feet.

PALEOZOIC ROCKS

Winnipeg Formation

According to Ballard (1963, pl. 3), the Winnipeg Formation of Middle Ordovician age extends into the northwest corner of the county. In eastern North Dakota, the Winnipeg Formation is composed mainly of greenish-gray shale that generally has a thin basal sandstone member (Ballard, 1963, p. 5). Where it has been identified in eastern North Dakota, the Winnipeg unconformably overlies Precambrian rocks.

The Winnipeg Formation is not known to have been penetrated by any wells or test holes drilled in Cass County.

CRETACEOUS ROCKS

Cretaceous rocks underlie most of Cass County. These rocks have been extensively eroded in the central and eastern parts of the county; consequently, their distribution is not well known. The Cretaceous rocks tentatively are subdivided into the Dakota Sandstone, Graneros Shale, and Greenhorn Formation.

Dakota Sandstone

The oldest Cretaceous rocks in eastern North Dakota generally are referred to as the Dakota Sandstone. However, lack of knowledge concerning the thickness and lithology of these rocks prevents definite correlation with the Dakota Sandstone in areas farther west and south. The basal Dakota generally consists of fine to coarse white sand, but in some places it consists of interbedded silt, sand, and gray clay. The sand is generally clean, well sorted, angular to subrounded, and is composed largely of quartz. The sand beds are generally poorly cemented or not cemented at all. The upper part of the Dakota consists of interbedded black and gray shale, silt, and very fine, gray sand. Locally, lignite and other carbonaceous materials are present. The variation in lithology and a general decrease in grain size from east to west indicate that the Dakota Sandstone in Cass County is probably a littoral deposit formed in a transgressing sea.

The thickness of the Dakota Sandstone in Cass County ranges greatly. The greatest thickness of Dakota penetrated was 143 feet in test hole 3119 (139-52-27aaa). In the eastern part of the county it is considerably thinner, and a maximum of 20 feet was penetrated in test hole 3099 (143-50-31ccc2). The formation seems to be absent in many places in the eastern part, even where younger Cretaceous shales are present.

Graneros Shale

In previous geologic studies of Cass County, the Cretaceous shales were grouped under the general term Benton Shale (Brookhart and Powell, 1961, p. 70). Collection of additional subsurface data, however, has permitted differentiation of the shales into the Greenhorn Formation and the Graneros Shale -- based on lithologic correlations with similar rocks described by Flint (1955, p. 23-25) in northeastern South Dakota, and Baker (1967, p. 14-19) in southeastern North Dakota.

The Graneros Shale is predominantly a black, silty, noncalcareous to calcareous shale containing white or gray silt laminae and thin beds and lenses of fine white sand. Lignite and other carbonaceous material, pyrite crystals, and fish scales are locally abundant. The presence of thin beds and lenses of sand, carbonaceous material, and pyrite indicates that the shale probably was deposited in a shallow-water environment of restricted circulation.

The Graneros Shale underlies all of the county except the eastern part, where it probably was removed by preglacial erosion. In western Cass County, the Graneros conformably overlies the Dakota Sandstone, but in the eastern part of the county, the Graneros, in places, unconformably overlies the Precambrian rocks. The Graneros Shale is known to range in thickness from 0 to 157 feet; the greatest thickness penetrated was in a well drilled completely through the Graneros and into the Dakota Sandstone (143-51-18dad).

Greenhorn Formation

The Greenhorn Formation is a grayish-black marine shale that contains thin strata of limestone. The shale is highly calcareous and commonly contains abundant white specks and unidentifiable shell fragments of apparent marine origin.

Formerly, the Greenhorn Formation probably was coextensive with the Graneros Shale and covered the entire county. However, post-Cretaceous erosion removed the Greenhorn from the approximate eastern two-thirds of the county.

The Greenhorn Formation ranges in thickness from 0 to 110 feet. The greatest thickness penetrated was in a well drilled to the Dakota Sandstone at 140-54-19cdd (Klausing, 1966, p. 139).

Four test holes penetrated Cretaceous bedrock in the westernmost range of townships in Cass County. These were located 2 to 6 miles east of the Cass-Barnes county line, and the youngest Cretaceous unit penetrated was the Greenhorn Formation. However, Kelly (1964, p. 68, 131) reported the Carlile Shale and the Niobrara Formation in test holes located 1 to 2 miles west of the Cass County boundary. It is not known if these units extend into Cass County.

Topography of the bedrock surface

The topography of the bedrock surface in Cass County (pl. 1 in pocket) was formed during Tertiary time by subaerial erosion and later was altered by glacial erosion. The map is based entirely on subsurface data, and is therefore somewhat conjectural.

The bedrock surface in the western part of the county seems to be rather flat, but in the central and eastern parts it is greatly dissected. The general slope of the bedrock surface is to the east. The most prominent features are the two northward-trending valleys in the central and eastern parts of the county. The two valleys differ in that the westernmost one is wider and generally not so steep sided as the one to the east. The eastern valley is a northward continuation of a valley originating in southern Richland County (Baker, 1967, pl. 2). This valley, which may be the ancestral Red River, turns east at Fargo and extends into Minnesota.

Pre-Pleistocene history

Very little is known about the geologic history of the Precambrian to Cretaceous interval in Cass County. The area is located on the eastern flank of the Williston Basin and may not have received sediments during the Paleozoic and Mesozoic

Eras, with the possible exception of the Middle Ordovician (Ballard, 1963, p. 30). Rather, it seems likely that much of Cass County, especially the eastern part, was topographically high during most of Paleozoic and Mesozoic time. During this long interval, the Precambrian rocks were deeply weathered and probably served as sources for some of the basin sediments to the west.

When the Cretaceous seas invaded the area, they covered an irregular and deeply weathered surface. The first advance of the sea was slow, and shallow water probably covered all of the area except for hills and knobs of Precambrian rocks that protruded above the sea as islands. The sediments deposited during this advance consist of interbedded clay and sand that were deposited in a littoral environment. The rock unit formed from these sediments is called the Dakota Sandstone.

Later in Cretaceous time, the area was completely covered by water. The sediments deposited were mostly black organic mud (Graneros Shale). The presence of pyrite and carbonaceous material in the shale indicates a brackish-water environment; numerous thin beds and lenses of fine sand suggest that the shoreline was not far away. Apparently, the brackish-water conditions gave way to a marine environment resulting in the formation of carbonate sediments interspersed with calcareous muds. These sediments, on compaction and lithification, formed the Greenhorn Formation. The younger Cretaceous deposits that are present farther west (Carlile Shale, Niobrara Formation, and Pierre Shale) are not known to be present in the county. Undoubtedly the sediments forming these rocks were deposited in the county, but were subsequently removed.

After the Cretaceous seas receded, the area was subjected to subaerial erosion. This period of erosion lasted throughout the Cenozoic Era and was terminated when the Pleistocene glaciers overrode the area.

PLEISTOCENE GEOLOGY

Cass County is completely covered with glacial drift. The thickness of the drift (including the glacial Lake Agassiz deposits) ranges from 132 to 447 feet and averages more than 250 feet. The variations in thickness are due primarily to bedrock irregularities, as shown on plate 1.

The surficial deposits of the county were formed as the last ice sheet receded from the area in late Wisconsin time. However, evidence of older drift deposits in several parts of the county was discovered by test drilling. The age of the older drift deposits is largely unknown.

Subsurface units

The major subsurface units discussed in this section are buried outwash, undifferentiated stratified drift, older till, and buried lake deposits.

OLDER TILL

Studies made by Flint (1955) in South Dakota and by Lemke and Colton (1958) and others in North Dakota indicate that eastern North Dakota was glaciated several times during Pleistocene time. Thus, it seems reasonable to assume that the relatively thick deposits of drift underlying Cass County are composed of several tills of different ages. There are, however, no outcrops in the county in which more than one till has been differentiated; and differentiation of tills by examination of drill cuttings is very uncertain.

The till penetrated in the test holes drilled during this study was chiefly light to olive gray in color, but in places the test holes penetrated both olive-gray and dark-greenish-gray till. The darker till appeared to have no common horizon and its color may be a local phenomenon caused by included bedrock fragments.

Seven test holes, 139-49-28bab, 140-49-14dcd, 140-49-29ddd, 141-49-9baa2, 141-51-25ddd, 142-50-3bbb, and 142-53-1bab, drilled during the course of this study, penetrated brown, oxidized (?) till at depths of 116 to 332 feet below land surface. These oxidized (?) zones, which range in thickness from 4 to 42 feet, are evidence of older till underlying the surficial drift. Dennis and others (1949, p. 26-29) recognized older till in the subsurface in the vicinity of Casselton; however, a reevaluation of their sample logs indicates that the older till is not as thick and extensive as previously indicated. The altitudes of the weathered zones vary greatly, and several older drift sheets may be represented.

The paucity of weathered zones within the till probably is a result of glacial erosion. As each ice sheet moved across the area, it probably removed much of the drift left by the preceding ice sheet, including most of any weathered surface that had formed.

BURIED OUTWASH

Test drilling revealed the presence of a few bodies of buried outwash. The approximate boundaries of the outwash bodies are shown on figure 5.

The most extensive outwash body underlies an area of about 155 square miles in the northwestern part of the county. The outwash body is overlain and underlain by glacial till, and its top is between 40 and 140 feet below land surface.

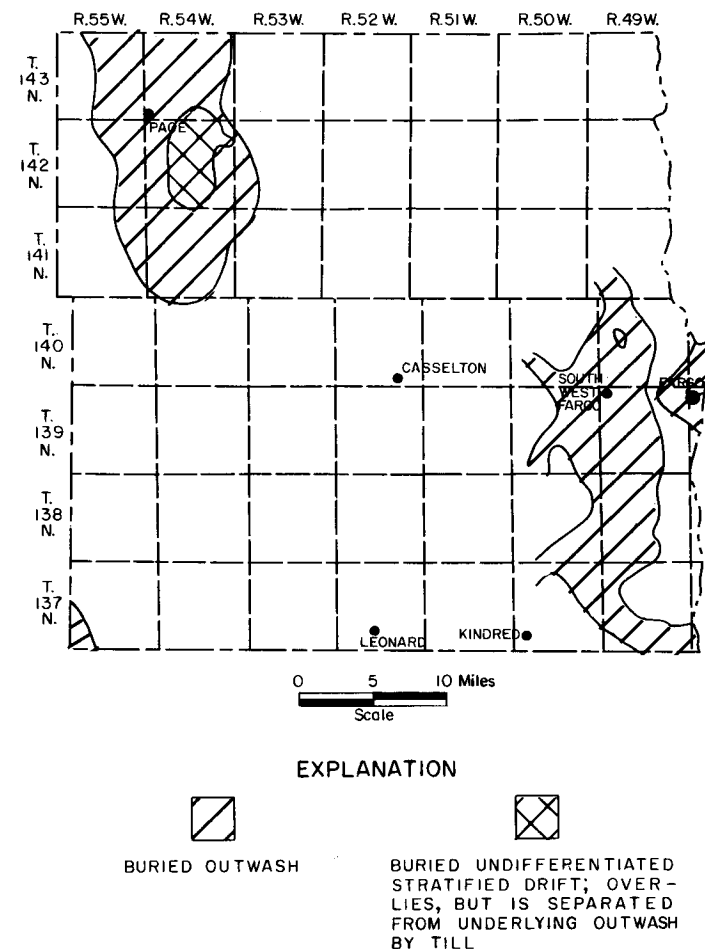

FIGURE 5. Approximate location of larger bodies of buried outwash.

The deposits range in texture from fine sand to coarse gravel, but the dominant texture is fine to medium sand. This outwash body, which ranges in thickness from 0 to 51 feet, is a water-supply source for the city of Page and surrounding farms.

A large body of outwash underlies the community of West Fargo. Test-hole data and well records indicate that the deposit underlies parts of Tps. 137 to 140 N., R. 49 W. South of T. 140 N., the thicker parts of the outwash body are confined to two separate channels that extend southward and converge into a single outwash channel. This channel trends south and east and probably extends into

Minnesota.

The outwash in the vicinity of West Fargo is overlain by till and generally rests on Cretaceous or Precambrian rocks; however, in a few places it rests on till. The outwash body lies between 90 and 140 feet below land surface and is composed of materials ranging in size from fine sand to boulder. The thickness of this unit ranges from 0 to 140 feet.

Large quantities of ground water are withdrawn from this outwash body. Dennis and others (1949, p. 34) identified the aquifer associated with the deposits as the "West Fargo aquifer."

A small buried outwash deposit underlies an area of about 6 square miles in the vicinity of Fargo. This deposit is overlain by till and rests either on till or granite. Generally its top lies between 90 and 150 feet below land surface. The deposit consists of sand and fine gravel and ranges in thickness from 0 to 160 feet. Test-hole data and well records indicate that the outwash body extends into Minnesota. A few industrial wells in Fargo withdraw water from this outwash deposit, and Dennis and others (1949, p. 34) named the aquifer the "Fargo aquifer."

A buried outwash deposit underlies an area of about 10 square miles in the southwestern part of the county. This deposit is overlain by 5 to 30 feet of till and rests on till. It consists of sand and coarse gravel and has a known maximum thickness of 80 feet. Sand and gravel, believed to be part of this deposit, is exposed along the south wall of an intermittent stream channel in the NE1/4 sec. 31, T. 137 N., R. 55 W. These deposits have an exposed thickness of 10 to 15 feet. The uppermost part consists of poorly sorted gravel that overlies laminated, fairly well-sorted sand (fig. 6). Several farm wells pump water from an aquifer associated with this outwash body.

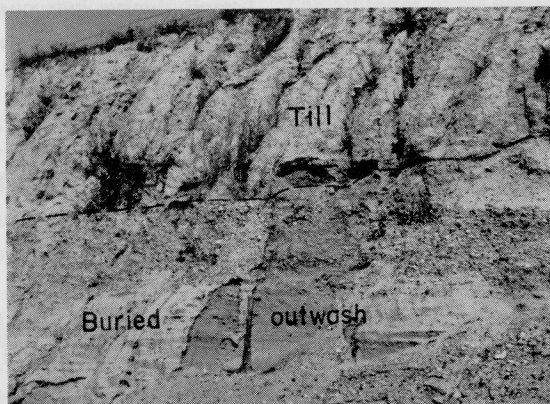

FIGURE 6. Buried outwash exposed on south side of intermittent stream channel (NE1/4 sec. 31, T. 137 N., R. 55 W.).

BURIED STRATIFIED DRIFT, UNDIFFERENTIATED

Deposits of silt and very fine sand, capped by 1 to 5 feet of till, are exposed in a railroad cut in the NE1/4NW1/4 sec. 20, T. 142 N., R. 53 W. These deposits have an exposed thickness of 10 to 20 feet (fig. 7). Similar deposits are exposed in railroad cuts in secs. 21 and 28, and in several other localities in T. 142 N., R. 54 W. Fine to coarse sand, overlain by 9 to 14 feet of till, was penetrated in two test holes (142-54-1bbb and 142-54-8ddd) drilled in the northern part of T. 142 N. Fine to medium, clayey sand, capped by 19 feet of till, was penetrated in a test hole drilled near the south edge of the township. The silt and sand deposits are not known to be continuous, but the similarity of stratigraphic position suggests that they may represent a single large body of stratified drift. The deposits are known to range in thickness from 10 to 78 feet.



FIGURE 7. Buried stratified drift, undifferentiated, exposed in railroad cut in NE1/4 NW1/4 sec. 20, T. 142 N., R. 53 W. (view looking north).

BURIED LAKE DEPOSITS

Dennis and others (1949, p. 26) described older lake deposits within the till near Casselton and discussed the probability that a lake existed in that area prior to the formation of glacial Lake Agassiz. The "older lake deposits" described by Dennis and others (1949) are not extensive, and very few examples of older

lake clay were found within the Lake Agassiz basin during the present study. This is to be expected, however, because much of such a deposit probably would be destroyed by glacial erosion.

Thick deposits of silt and clay were penetrated in two test holes drilled in the northeastern part of the county. The silt and clay are as much as 180 feet thick (pl. 2, section A-A'; in pocket), and probably represent a former glacial lake.

Drift of late Wisconsin age

TILL AND ASSOCIATED STRATIFIED DRIFT

The surficial features in Cass County are composed of glacial drift of late Wisconsin age, and have been altered very little by post-Pleistocene erosion. The features can be separated into till and associated stratified drift deposits of the Drift Prairie physiographic division, and the lacustrine deposits of the Red River Valley physiographic division. Surficial geologic features are shown on plate 3 (in pocket).

Upham (1895) and Leverett (1912, 1932) mapped separate end moraines in western and southwestern Cass County. However, work done during the present study did not reveal any evidence of end moraines in the county. The proposed end moraines do not coincide with existing topographic "highs," and aerial photographs do not show any lineation patterns coincident with the courses described. Most of the area through which Upham's "Fergus Falls moraine" (1895, pl. XIX) passes is nearly flat to slightly rolling and has none of the characteristics generally ascribed to end moraines. Also, according to Upham (1895, p. 160), the eastern boundary of the Fergus Falls moraine in Cass County was marked by numerous kames of sand and gravel. However, no kames were found in this area. T.E. Kelly (oral communication) did not identify the Fergus Falls moraine in adjacent Barnes County. Leverett (1912, fig. 1; 1932, p. 111) mapped a north-south "morainal belt" in southwestern Cass County; however, there are no topographically high areas or other indications of morainal deposition in that part of the county.

Till

The composition of the till varies greatly. In places it consists chiefly of silt, but in other places it consists largely of clay intermixed with sand and gravel. Boulders are common but not abundant; cobbles are locally abundant. In surface exposures, the color of the till is moderate yellowish brown because of oxidation. The thickness of the zone of oxidation generally ranges from 10 to 30 feet.

No exposures of unoxidized till are known to occur within the county, but samples from test holes are olive gray to dark greenish gray.

Three till landforms have been recognized in Cass County: ground moraine, washboard moraine, and a kettle chain.

Ground moraine.--Areas of till having low relief and lacking definite linear trends are called ground moraine (Flint, 1955, p. 111).

Ground moraine covers about 480 square miles in western Cass County (pl. 3), and extends into Barnes and Steele Counties. It is bounded on the east by beach deposits of glacial Lake Agassiz. The topography varies from nearly flat to strongly rolling, with local relief ranging from 5 to 50 feet.

Washboard moraines.--Washboard moraines are characterized by numerous



FIGURE 8. Washboard moraines in southwestern Cass County. Vertical airphoto.

low, subparallel, discontinuous ridges of till. In Cass County, these ridges trend northwest-southeast and rise from 10 to 15 feet above the surrounding terrain. The ridges are minor recessional features that mark cyclic pauses of the ice front during deglaciation (Winters, 1963, p. 19). They are slightly convex to the southwest, indicating that the last ice sheet receded in a northeasterly direction. The linear pattern displayed by the ridges and the intervening depressions is not apparent in the field, but is easily seen on aerial photographs (fig. 8). Washboard moraines are common in the southwestern part of the county and extend into adjacent areas in Barnes and Ransom Counties.

Kettle chain.--A kettle is a depression in the drift caused by the wasting away of a completely or partially buried ice block. According to Flint (1953, p. 148), the largest and most conspicuous kettles result from the melting of relatively thick projecting ice masses. This type of kettle has steep-sided slopes that were formed by slumping of the sediment when the supporting ice melted away. Smaller buried ice masses result in shallow kettles.

A rather prominent chain of kettles extends south of Alice for about 8 miles in southwestern Cass County. The kettles are elongate in a north-south direction and some are as much as 1-1/2 miles long. They range in width from about half a mile or less to nearly a mile, and have flat bottoms and steep sidewalls in which till is exposed. Some are as much as 25 feet deep, nearly all contain lakes or marshes that become dry during periods of prolonged drought.

Stratified drift

Surficial deposits of stratified drift in Cass County consist of kames, eskers, outwash channel deposits, and river terrace deposits. The location of these units is shown on plate 3.

Kames.--Kames are low mounds and irregular-shaped hills composed of washed drift that was deposited within, or at the edge of, glacial ice by melt-water streams. The kames in Cass County range in height from 5 to 25 feet and have gently sloping sides (fig. 9). They are composed of poorly sorted silt, sand, and gravel. The sand and gravel deposits generally are poorly stratified, but well-stratified silt and sand beds are not unusual. The bedding ranges from horizontal to tilted. The tilted bedding was caused by slumping after the supporting ice walls melted.

Many of the kames or kamelike features are closely associated with eskers, and in places the two types of features cannot be differentiated; therefore, they are shown on the landforms map as one unit.

Eskers.--Eskers, which are sinuous ridges of stratified drift deposited by melt-water streams flowing in tunnels or channels in the glacial ice, are unusually



FIGURE 9. Typical kame in NE cor. sec. 3, T. 137 N., R. 55 W. View looking southwest.

common in western Cass County. They are most abundant in the vicinity of Page where they stand from 10 to 40 feet above the adjacent ground moraine. Most of the larger eskers consist of sinuous to nearly straight segments that are as much as 1-1/2 miles in length. The gaps between the segments generally are less than a quarter of a mile in length. The longest esker in the county is 1 mile west of Page and has a total length of about 7 miles, including the gaps. It consists of a series of steep-sided, irregular ridges and mounds that rise between 10 and 20 feet above the adjacent ground moraine.

Most of the eskers are composed of poorly sorted sand and gravel. Generally the range in grain size is small, but some deposits range widely in grain size. Till is commonly draped over the flanks of the eskers and, in places, forms a thin mantle on their crests (fig. 10). In some eskers, till is locally intermixed with sand and gravel. The degree of bedding in the sand and gravel varies considerably. Some of the deposits are distinctly bedded, but in others the bedding is very indistinct (figs. 10 and 11). The bedding is horizontal to tilted.

Exposures of eskers in pits and road cuts show thicknesses of stratified drift ranging from 3 to 10 feet. Auger holes, drilled by the Cass County Road Department in an esker in the NW1/4 sec. 36, T. 143 N., R. 55 W., showed thicknesses of as much as 20 feet.

Maple River deposits and associated terraces.--The proglacial Maple River valley extends southward from the north edge of T. 140 N., R. 55 W. into Ransom County. The valley ranges in width from about one-tenth to half a mile and has gently to steeply sloping walls. North of its confluence with the outwash channel that extends southeasterly from Tower City, the Maple River valley is from 10

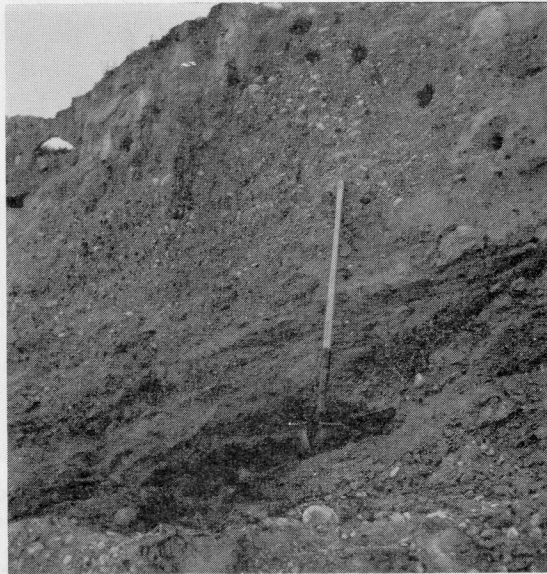

FIGURE 10. Poorly bedded sand and gravel in esker, NE1/4 sec. 17, T. 138 N., R. 54 W. View looking south.



FIGURE 11. Bedded sand and gravel in esker, SE1/4 sec. 28, T. 141 N., R. 55 W. View looking south.

to 20 feet deep. South of the confluence, the valley is 20 to 40 feet deep.

The valley of the Maple River is mantled with alluvium, which has a maximum known thickness of 6 feet. Test holes drilled in secs. 22 and 27, T. 140 N., R. 55 W., penetrated 1 to 2 feet of alluvium underlain by glacial outwash. The outwash consists of yellow clay, sand, and gravel that has a maximum thickness of about 14 feet. The sand and gravel beds are thin, ranging from 2 to 7 feet in thickness. It is not known if outwash underlies the alluvium in the Maple River valley south of T. 140 N. Several holes were augered to a depth of 6 feet, but none of them completely penetrated the alluvium.

Near the SW cor. T. 137 N., R. 55 W., the bottoms of three "hanging" channels are as much as 20 feet above the bottom of the southeasterly-trending channel to which they are tributary. The tributary channels contain outwash of undetermined thickness that is overlain by 1 to 2 feet of alluvium.

The "hanging" channels probably are diversion channels that were formed during earlier phases of the Maple River. When the ice east of the channels melted, a lower drainageway formed and the channels were abandoned.

Terrace remnants, which are most numerous along the east wall of the Maple River valley, are from 5 to 30 feet above the present flood plain. The terrace remnants range from a few hundred feet in length and width to more than a mile long and half a mile wide. North of the confluence of the Maple River and the outwash channel that extends southeasterly from Tower City, there is only one terrace, but south of the confluence there is evidence of two terraces. Where there are two terraces, the lower one is generally well defined, having a relatively flat surface and an abrupt scarp (fig. 12). The higher terrace remnants, which stand 10 to 20 feet above the lower terrace, generally are mantled by deposits of collu-

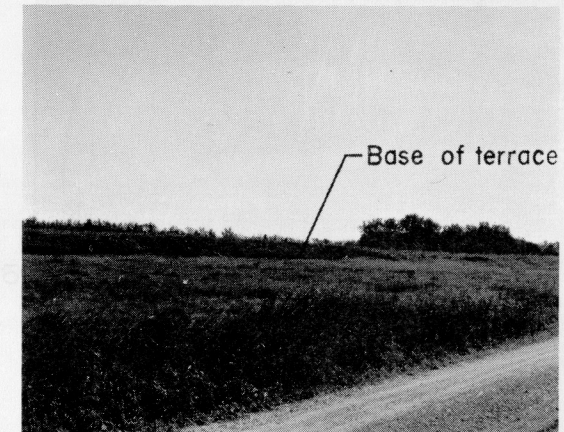

FIGURE 12. Lower terrace, east side of Maple River in NW1/4 sec. 3, T. 138 N., R. 55 W. View looking east.

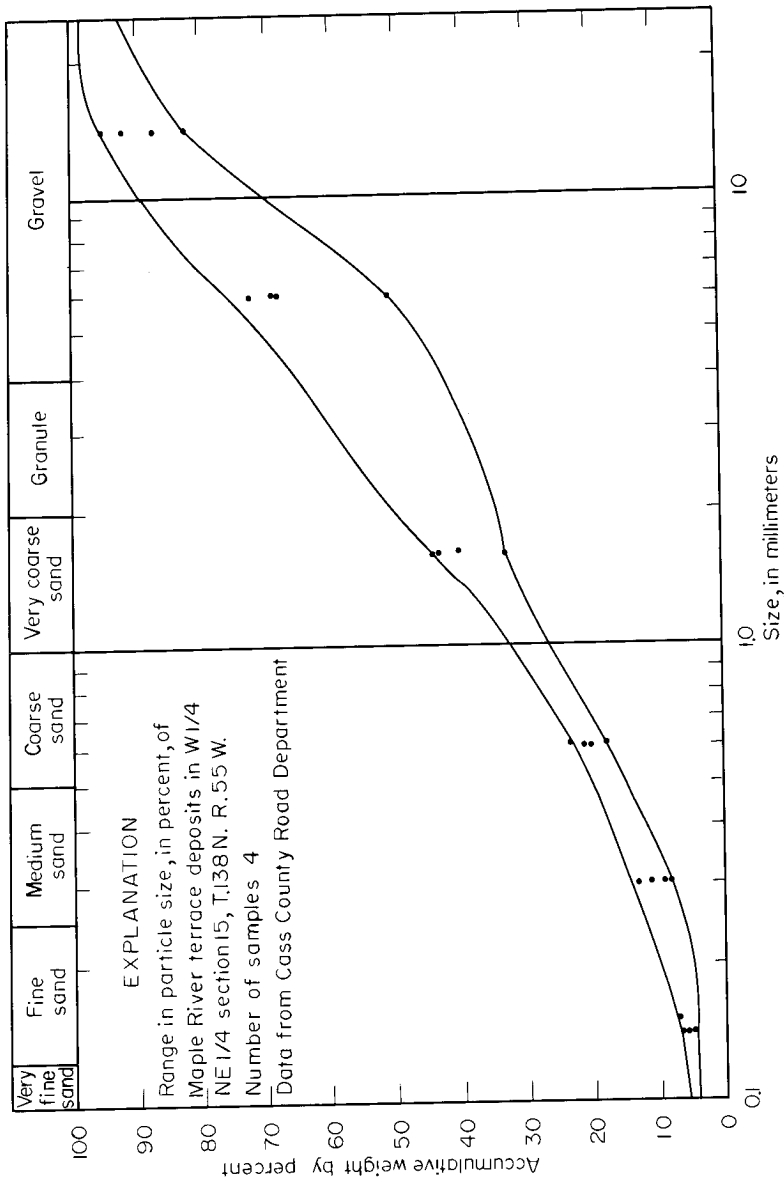

FIGURE 13. Particle size distribution of samples from terrace remnant (W1/2NE1/4 sec. 15, T. 138 N., R. 55 W.).

vium, and are less distinct.

The terrace deposits are composed of silt, sand, gravel, and boulders, but sand and gravel are the dominant size fractions (fig. 13). The deposits generally are poorly bedded, but well-stratified beds of sand and gravel are not uncommon (fig. 14). The deposits range in thickness from 0 to 20 feet.

The Maple River terraces are erosional remnants of an early period of valley development that occurred during the retreat of the ice from the area. The terraces probably were formed during the early stages of glacial Lake Agassiz; however, correlation of the terraces with separate stages of the lake cannot be made.

During the formation of the Maple River valley south of the north edge of T. 140 N., glacial ice apparently occupied the area to the north. This is evidenced by the absence of outwash or terrace deposits along the river north of T. 140 N. Also, there is no distinguishable valley associated with this part of the river, indicating that the Maple River north of T. 140 N. is of postglacial origin.

Ice-marginal outwash channels and associated deposits.--During melting of the last ice sheet, several outwash channels were eroded along successive margins of the northeasterly receding ice sheet. T. E. Kelly (written communication) mapped seven such outwash channels in eastern Barnes County. Six of the channels were reported to trend southeastward from Barnes County and into Cass County, but only three could be identified as outwash channels in Cass County. The other three channels are represented in the county by small, linear bodies of stratified

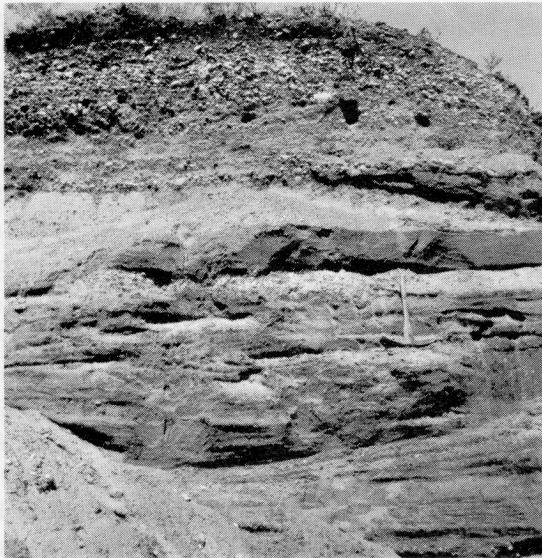

FIGURE 14. Stratified sand and gravel in terrace deposit, east side of Maple River in NW1/4 sec. 15, T. 138 N., R. 55 W.

drift that were laid down on or adjacent to stagnant ice. A brief discussion of each of the outwash channels and stratified drift bodies follows.

The outwash channel extending southeasterly across the northwestern part of T. 137 N., R. 55 W., ranges in width from one-tenth to a quarter of a mile. It has a gently concave bottom and steep-sided walls that rise as much as 40 feet above the channel floor. Locally, terrace remnants flank the walls of the channel, but most of the terraces are of minor extent and are not differentiated from the channel deposits in plate 3. The channel deposits are composed of sand and gravel and have a known maximum thickness of 6 feet. The thickness of the terrace deposits is not known, but is probably less than 6 feet. The channel deposits are overlain by 2 to 3 feet of alluvium and, in places, the terraces are covered with a thin veneer of slope wash.

The outwash channel extending southeasterly across the southwestern part of T. 140 N. and the northwest part of T. 139 N., R. 55 W., ranges in width from one-tenth to half a mile. This channel has a relatively flat floor and gently sloping walls that rise 20 to 30 feet above the channel floor. The channel deposits are composed of sand and gravel that are as much as 22 feet thick. The sand and gravel deposits are overlain by 1 to 2 feet of alluvium and are underlain by till. The sand and gravel deposits in this channel are saturated, and serve as a water-supply source for Tower City.

The outwash channel in the NW cor. T. 141 N., R. 55 W., ranges in width from one-tenth to half a mile. The channel has a flat floor bordered by gently sloping walls 5 to 10 feet high. The western part of the channel contains no outwash, but the eastern part contains fine to coarse sand of unknown thickness.

The outwash deposit in the SW cor. T. 142 N., R. 55 W., is topographically higher than the floor of the intermittent stream channel with which it seems to be associated, and lies at about the same level as the adjacent ground moraine. Local relief generally is less than 5 feet. The deposit is known to be as much as 6 feet thick, and is composed chiefly of sand and fine gravel. The topographic position and the linear form of the deposit suggest that it was laid down in a channel that was at least in part floored on stagnant ice and was subsequently lowered unto the underlying till when the ice melted.

The western part of the small outwash body in the SW cor. T. 143 N., R. 55 W., is confined to a shallow channel, but the eastern part is unconfined and lies on nearly flat ground moraine. Local relief is generally less than 5 feet. The outwash is composed of sand and gravel, and is overlain by 1 to 2 feet of alluvium. The outwash is known to be at least 6 feet thick, but the maximum thickness is unknown. The eastern part of the outwash body probably was laid down in water that was ponded in front of stagnant ice.

The outwash body in the NW cor. T. 143 N., R. 55 W., occupies an area of about 3 square miles. The deposits in the western part of the body have no definite topographic expression, but the deposits in the eastern part stand 5 to 10 feet above the surrounding terrain. There is a gradual increase in altitude from west to east and the eastern part generally is 15 to 20 feet higher than the western part. The deposits are composed chiefly of sand and gravel, but boulders as much as 2 feet in diameter are intermixed with the sand and gravel in a gravel pit located in the SW cor. sec. 6. The deposits are as much as 25 feet thick in the aforementioned gravel pit. Most of these deposits were laid down on or adjacent to stagnant ice by melt water discharging from an outwash channel in adjacent Barnes County (Kelly, 1967, pl. 1). Some of the sand and gravel deposits probably are collapsed outwash.

LAKE AGASSIZ DEPOSITS

Most of Cass County, about 1,270 square miles, lies below the highest shoreline and within the area covered by glacial Lake Agassiz. The Lake Agassiz deposits in Cass County can be divided into the Sheyenne delta, Maple delta, shore deposits, and lake-plain deposits. The locations of these deposits are shown on plate 3.

Sheyenne delta

The Sheyenne delta was named and described by Upham (1895, p. 315-317). Leverett (1912, 1932) and Elson (1957) believed that the feature was a deposit of ice contact stratified drift. Later studies made in Cass County (Dennis and others, 1950) and in Richland County (Baker, 1967) support Upham's theory of deltaic origin. Data collected from test holes and surface exposures during the present study also indicate that the feature is of deltaic origin.

The Sheyenne delta occupies an area of about 60 square miles in the south-central part of Cass County. Northeast of Leonard, the edge of the delta is marked by a rather steep northeastward-facing escarpment that rises 75 to 100 feet above the lake plain. To the west, the deposits merge with the smaller Maple delta, and to the northwest, with the littoral deposits of glacial Lake Agassiz. The northeast-facing escarpment of the Sheyenne delta is continuous with the Campbell beach and is believed to be a wave-cut slope formed during the Campbell stage of the lake.

The Sheyenne delta deposits in Cass County consist chiefly of finely laminated silt and very fine to medium sand. In some exposures along the face of the delta, the deposits consist of silt and very fine sand interbedded with thin layers of dark-gray clay.

The exact thickness of the deposits at any given location is difficult to determine. The lower beds of the delta have essentially the same texture and composition as the lake-floor deposits. Therefore, no definite boundary can be drawn between the delta and lake-floor deposits. The greatest thickness of silt and sand penetrated during test drilling on the Sheyenne delta was 121 feet in test hole 137-52-31bbb.

If the escarpment of the Sheyenne delta was formed during the Campbell stage of glacial Lake Agassiz, the time of formation of the delta is fixed. Most of the delta probably was formed before the lake declined to the Campbell level.

Maple delta

The Maple delta is located in the southwest part of T. 137 N., R. 54 W. It is a small northeast-southwest-trending deposit bordered on the northwest by the littoral deposits of glacial Lake Agassiz, and on the southeast by the Sheyenne delta. The Maple delta is deeply entrenched along its long axis by the northeastward-flowing Maple River. The boundaries of the delta, as shown on plate 3, enclose only the sand and gravel facies of the deposit. The complete extent of the delta deposits is unknown because the finer sediments cannot be differentiated from the adjacent littoral deposits of Lake Agassiz and deltaic deposits of the Sheyenne River.

The Maple delta deposits are composed of silt, sand, gravel, and a few boulders. The predominant lithology is fine to coarse sand. The boulders are probably ice-rafted erratics.

Little is known concerning the thickness of deposits in the Maple delta. The only test hole (137-54-32ddd) drilled in the delta penetrated 49 feet of sand and gravel and 10 feet of silt before reaching the underlying till. It is not known if the silt is deltaic or lacustrine in origin.

The time of formation of the Maple delta is not definitely known, except that it probably was contemporaneous with the Sheyenne delta.

Shore deposits

A 4- to 10-mile wide belt of stratified gravel, sand, silt, and clay, which was formed along the western shore of Lake Agassiz, extends from the Maple River in southern Cass County northward to the northern edge of the county (pl. 3). The shore deposits were formed on a wave-eroded till surface; they are poorly sorted to well sorted and range in thickness from 0 to as much as 15 feet (fig. 15).

In most places, the deposits have little surface expression except a gentle eastward slope. However, in places well-defined beach ridges are discernible on the ground and in aerial photographs, and the crests of these ridges are shown in

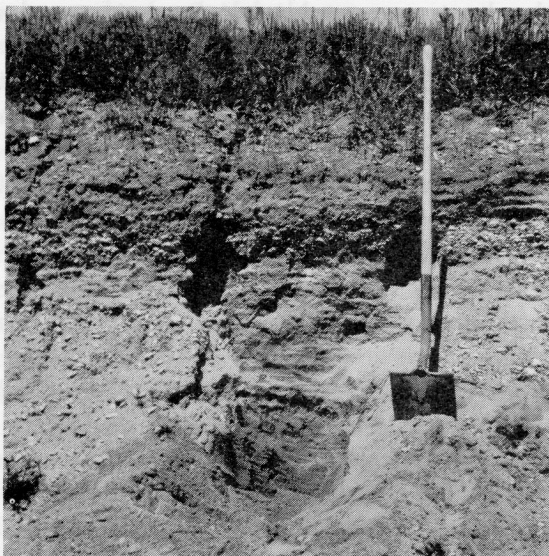

FIGURE 15. Typical beach deposit in SW1/4 sec. 1, T. 141 N., R. 53 W. View of Tintah beach looking west.

plate 3. Upham (1895) described eight beaches that cross Cass County. These he named from oldest to youngest: Herman, Norcross, Tintah, Campbell, McCauleyville, Blanchard, Hillsboro, and Emerado. However, work done during this study revealed no evidence of the Blanchard and Emerado beaches in Cass County, and the McCauleyville and Hillsboro beaches are not as extensive as Upham indicated. Upham (1895, p. 221) believed that the five upper beaches (Herman through McCauleyville) were formed during the time Lake Agassiz drained southward through the Minnesota River. The lower beaches, according to Upham, were formed during the time that the lake drained to the northeast. Leverett (1932, p. 139) disagreed with Upham's interpretation of the time of formation of the McCauleyville beach, and concluded that Lake Agassiz had no connection with the southern outlet during the McCauleyville stage.

The four upper beaches extend in a southwesterly direction from the north edge of the county and merge with the Sheyenne and Maple deltas southeast of Alice. Of the lower beaches, only the McCauleyville and Hillsboro, which are prominent east of Hunter, extend into the county (pl. 3).

Herman beach.--The highest continuous shoreline of Lake Agassiz was named the Herman beach by Upham (1895, p. 317). The beach enters the north end of the county in sec. 6, T. 143 N., R. 53 W., and extends in a southerly direction almost the entire length of the county to the north edge of sec. 31, T. 137 N., R. 54 W. where it becomes indistinct.

The Herman shoreline is represented both by beach ridges and wave-cut slopes. In the northwestern part of T. 143 N., R. 54 W., the shoreline is a wave-cut escarpment in the till. A short distance to the east the escarpment is paralleled by a low ridge of sand and gravel that probably formed as an offshore bar. From Erie southward to the north edge of T. 138 N., R. 54 W., the Herman beach consists of sand and gravel and has the appearance of a wave-cut slope. South of T. 138 N., R. 54 W., to its terminus at the north edge of sec. 31, T. 137 N., R. 54 W., the beach is a low ridge of sand and gravel.

Norcross and Tintah beaches.--The Norcross and Tintah beaches parallel the Herman beach on the east. Generally they are low discontinuous ridge segments, but in a few places they appear to be wave-cut slopes. Generally the beach deposits consist of sand and gravel. In the western part of T. 143 N., R. 52 W., the Tintah beach is a broad prominent ridge consisting chiefly of sand.

Campbell beach.--The Campbell beach is a prominent wave-cut slope that enters the county about 2-1/2 miles north of Hunter. It extends in a south to southwesterly direction to the north edge of sec. 5, T. 138 N., R. 53 W. From this point the beach extends in a southeasterly direction and leaves the county about 6 miles southeast of Leonard. Southeast of the Maple River, the Campbell beach has been eroded into the northeast-facing slope of the Sheyenne delta. The exact location of the beach is not definitely known because there are no prominent erosional features with which the beach can be correlated; however, the beach probably corresponds to the 1,000-foot contour.

The Campbell beach rises 5 to 25 feet above the adjacent lake floor and consists for the most part of silt and sand.

Lower beaches.--The two beaches below the Campbell are the McCauleyville and Hillsboro. The McCauleyville is a low wave-cut slope eroded in clay. The east-facing slope is fairly prominent where it crosses the section line road between secs. 24 and 25, T. 143 N., R. 52 W.

The Hillsboro beach, which is the more prominent of the two lower beaches, enters the county at the north edge of sec. 6, T. 143 N., R. 50 W., and extends southwesterly for a distance of about 12 miles to the south edge of T. 142 N., R. 51 W. The beach is composed chiefly of silt and very fine sand. Upham (1895, p. 450) correlated the Hillsboro beach with the Maple ridge; however, the features are unrelated in origin.

Lake-plain deposits

The Lake Agassiz plain occupies approximately the eastern half of the county and lies, for the most part, between the altitudes of 895 and 1,000 feet above sea level. The plain is flat and featureless except for a few low ridges. The lake-plain

deposits consist almost entirely of silt and clay.

Dennis and others (1949, p. 18,20) divided the lake-plain deposits into two units, an upper "silt" unit and lower "clay" unit. They concluded that the lake had been drained and refilled at least once, and that the silt unit had been laid down in shallow water during the later lake stage. Brophy (1963, p. 23A) provided additional evidence of two lake intervals when he reported the presence of plant remains and a dessication zone at the contact between the silt and clay units. Radio-carbon dates reported by Brophy indicate that deposition of the silt unit began about 9,900 years ago. Test-hole data collected during the present investigation verify the existence of two lake deposits throughout most of the county east of the Campbell shoreline.

Differentiation of the silt and clay units is generally based on changes in texture; however, in many places it is extremely difficult to differentiate the two units from drill cuttings. In such cases, color is used as a criterion for distinguishing the two units. The silt unit is generally yellowish brown to yellowish gray, whereas the clay unit is almost always olive gray to dark greenish gray.

Silt unit.--In Cass County, the silt unit is the predominant lake-floor deposit. It rests disconformably upon the clay unit and is composed chiefly of yellowish-brown to yellowish-gray silt. Locally the "silt" unit may consist entirely of clay or sand. It ranges in thickness from 0 to as much as 54 feet in test hole 143-52-36ddd.

In many places deposits of sand underlie or are associated with the silt unit. The presence of these deposits at the base of the silt suggests that a fluvial environment existed prior to deposition of the silt unit. In the vicinity of Kindred, the silt unit, locally, is underlain by very fine to coarse sand that is as much as 50 feet thick. Dennis and others (1949, p. 25) concluded that part of this sand body had been eroded from the face of the Sheyenne delta and redistributed lakeward by wave action during the Campbell stage of Lake Agassiz, and that the rest was deposited by the Sheyenne River during the interlake period preceding deposition of the silt. Dennis and others (1949, p. 25) believed also that the sand thickened toward the delta. The available data, however, indicate that the sand does not thicken toward the delta (pl. 1, section C-C'). The proximity of the shallow sand deposits to the Sheyenne River, and the apparent absence of sand in the area between Kindred and the Sheyenne delta, suggest that the sand deposits at Kindred are fluvial in origin.

Clay unit.--The clay unit underlies the silt unit and rests unconformably upon the till and associated deposits. This unit consists of olive-gray to dark-greenish-gray plastic clay. Locally it is silty, and, occasionally ice-rafted sand, gravel and boulders are found in the clay. Test drilling and well records indicate that the clay unit ranges in thickness from 0 to as much as 82 feet in test hole 140-49-36aaa.

Maple and Sheyenne ridges.--Two long ridges, which rise 5 to 20 feet above the surrounding lake plain, are the most prominent features in the southeastern part of the county (pl. 3). The ridges consist of silt, sand, and gravel. The upper 10 to 25 feet consists of silt; it is underlain by sand and gravel that may be as much as 25 feet thick. The sand and gravel deposits, in turn, are underlain by lake clay.

The westernmost ridge, called the Maple ridge by Upham (1895, p. 450), lies northwest of the Maple River, and parallels the river for a distance of about 15 miles. The Sheyenne ridge lies east of the Sheyenne River, and parallels the river for a distance of about 12 miles. It stands 5 to 10 feet above the lake plain and extends northward from the NW cor. T. 137 N., R. 49 W. to the SW part of T. 139 N., R. 40 W. At this point, the ridge bifurcates and forms the Fargo and West Fargo ridges (Dennis and others, 1949, p. 11). This ridge has a lithologic sequence similar to that of the Maple ridge, and is believed to have had a similar origin.

Upham (1895, p. 450) suggested that the Maple ridge was part of the Hillsboro beach. He believed that it had formed as a result of deposition of material eroded from the margin of the Sheyenne delta and from the adjacent lakebed. Dennis and others (1949, p. 37) proposed that the sand and gravel deposits underlying the Maple River, Fargo, and West Fargo ridges could have originated either as near-shore deposits in a transgressing lake, or as fluvial deposits laid down during an inter-lake period. They further postulated (p. 37-38) that after recession of lake waters from the area, the ridges were formed as a result of differential compaction of the sediments. The sand and gravel deposits underlying the ridges were compacted less than the silt and clay deposits adjacent to the ridge.

The origin of the sand and gravel deposits underlying the ridges is questionable; however, the proximity and similarity of the trends of the ridges and the present streams, and the fact that the sand and gravel deposits extend down into the lake clay, suggest that the deposits were laid down by streams flowing across the lakebed during the inter-lake period. The main objection to a near-shore lacustrine origin is that there would be no source for coarse clastic material in a lake transgressing across a thick deposit of plastic lake clay. If the sand and gravel deposits extended farther south than the present limits of the ridges, they probably were redistributed by currents or wave action during the second stage of the lake.

Intersecting minor ridges.--Numerous intersecting lineations are present in the lowest and flattest part of the Lake Agassiz plain along the Red River. These features, which are apparent only on aerial photographs, extend northward from Fargo, N. Dak. into Canada. Horberg (1951) described the features as northwest-southeast-trending ridges that are 3 to 10 feet high, 75 to 100 feet wide, and as much as 6 miles long. According to Clayton and others (1965, p. 655) the lineations in Walsh and Pembina Counties, N. Dak. are predominantly ridges; but in

Cass County, the lineations are predominantly grooves. Horberg (1951, p. 15-16) concluded that the lineations are an unusual type of tundra or permafrost patterned ground. As an alternate theory, he proposed that the ridges are fracture fillings formed in lake ice. Colton (1958, p. 76) agreed with Horberg's alternate theory and suggested that the ridges probably were formed by squeezing up of the soft lake sediment into cracks in thick lake ice when the level of Lake Agassiz was at a low stage. Other workers (Nikiforoff, 1952, p. 99-103; and Elson, 1961, p. 70) proposed different origins for the linear features. Clayton and others (1965, p. 655) concluded that most of the intersecting ridges and grooves on the Lake Agassiz plain were formed by the dragging of thick sheets and blocks of wind-driven lake ice across the nearly flat bottom of glacial Lake Agassiz. According to them, this is the only theory that explains the pattern, orientation, and curvature of the ridges and grooves. They do not imply, however, that all the linear features in the Lake Agassiz basin were formed by the above mentioned process.

This writer agrees with Clayton and others in that most of the linear features were caused by dragging of wind-driven ice blocks across the lakebed.

RECENT DEPOSITS

Alluvium and dune sand are grouped under deposits of Recent age; however, these deposits probably range in age from late Pleistocene to Recent.

Alluvium

The alluvium consists of clay, silt, sand, and fine gravel that was deposited by postglacial streams. Only the alluvial deposits that form the flood plains of the larger streams were mapped. Thin deposits, laid down by the smaller intermittent postglacial streams, were not mapped. Likewise, thin deposits of clay and silt in undrained depressions in the ground moraine, as well as deposits of colluvium along the valley walls of some of the streams, were not differentiated from the underlying unit.

It is difficult to determine the thickness of the alluvium because of the lack of exposures. Augering in stream valleys and examination of exposures in undercut banks indicate that the alluvium is as much as 15 feet thick in places.

Dune sand

Mappable areas of dune sand are present on the Sheyenne delta in the vicinity of Leonard (pl. 3). The sand areas are characterized by hummocky topography, rather than distinct dunes, and the local relief is less than 10 feet. The dune sand was derived from the delta; consequently, the grain sizes (silt to fine sand) are about the same as those of the deltaic deposits. The surficial sand is usually grayish brown in color because of the presence of decayed organic matter. The color becomes brown to yellowish brown with depth as the dune sand grades imperceptibly into the underlying deltaic deposits.

PLEISTOCENE AND RECENT HISTORY

During Pleistocene time, Cass County probably was covered several times by continental glaciers. Drift of pre-Wisconsin age has not been recognized in eastern North Dakota, but Flint (1955, p. 30-41) identified drift of Nebraskan, Kansan, and Illinoian age in South Dakota. The distribution of pre-Wisconsin drift in South Dakota indicates that the glaciers advanced southward via the James River and Red River lowlands. During Wisconsin time, Cass County probably was covered by glacial ice three and possibly five times (Lemke and others, 1965, p. 13-26).

Each of the advancing ice sheets that crossed the county left deposits of drift, and each succeeding ice sheet removed and redistributed these deposits. The deposits left by the various ice sheets are so similar in lithology that they cannot be easily differentiated. Evidence of more than one drift sheet in the county can be found only in a few places.

Great thicknesses of glacial drift were deposited in the county and by the time of the last glacial recession, the pre-Pleistocene topography was completely buried. The northwest-southeast-trending washboard moraines and ice-marginal outwash channels located in the western part of the county indicate that the last ice sheet receded in a northeasterly direction. As the ice receded from the northward-sloping Red River Valley, a large proglacial lake, called Lake Agassiz, was formed in eastern North Dakota and western Minnesota. About three-fourths of Cass County was covered by the lake waters.

At its maximum, Lake Agassiz extended from northeastern South Dakota into Canada, where its area exceeded that in the United States. According to Upham (1895, p. 215), the average width of the lake was about 150 miles. The greatest depth of Lake Agassiz in Cass County during its maximum (Herman) stage was

about 150 feet. The lake had an outlet to the south through a valley now occupied by the Bois de Sioux River and a chain of lakes and marshes. Differential erosion of the bottom of the channel was accompanied by rapid declines of the lake level and resulted in the formation of well-defined shorelines. As the ice continued to recede, outlets were uncovered to the northeast, and Lake Agassiz gradually receded from Cass County.

Some of the more prominent features in Cass County were formed during the time glacial Lake Agassiz I occupied the Red River Valley. During the highest stage of Lake Agassiz, a well-defined shoreline (Herman shoreline) was formed, and an extensive delta, which extended into Cass County was formed at the mouth of the Sheyenne River. Another prominent shoreline (Campbell shoreline) probably was formed before Lake Agassiz I drained. The prominence of the Herman and Campbell beaches indicates that the lake stood at these levels longer than at any other.

After Lake Agassiz I receded from Cass County, the lake plain was subjected to subaerial erosion and, in places, there was abundant plant growth. During this interlake period, two streams, probably predecessors of the Sheyenne and Maple Rivers, deposited sand and gravel in shallow channels eroded into the lake plain.

The interlake period terminated about 9,900 years ago when a readvance of glacial ice blocked the northern outlets and caused the basin to be refilled to about the level of the Campbell beach.

When the glacial ice again receded sufficiently to uncover the northeastern outlets, the lake level lowered and gradually receded from Cass County. The lake must have been relatively shallow and of short duration because the shoreline features that were formed during this stage of the lake are not conspicuous. During this last stage of Lake Agassiz, wave action smoothed the lake floor and a blanket of silt was laid down on top of the existing lake clays.

After Lake Agassiz II had receded from Cass County, the lake plain had essentially the same form that is seen today. Recent erosion has produced no prominent changes in the late Pleistocene landscape.

SELECTED REFERENCES

- Allison, I. S., 1932, The geology and water resources of northwestern Minnesota: Minnesota Geol. Survey Bull. 22, 245 p.
- Baker, C. H., Jr., 1967, Geology and ground water resources of Richland County, North Dakota; Part I, Geology: North Dakota Geol. Survey Bull. 46 and North Dakota State Water Comm. County Ground Water Studies 7, 45 p.
- Ballard, F. V., 1963, Structural and stratigraphic relationships in the Paleozoic rocks of eastern North Dakota: North Dakota Geol. Survey Bull. 40, 42 p.
- Brookhart, J. W., and Powell, J. E., 1961, Reconnaissance of geology and ground water in Hunter area, Cass County, North Dakota: North Dakota State Water Comm. Ground Water Studies, no. 28, p. 69-91.
- Brophy, J. A., 1963, Evidence for Lake Agassiz I-II interval in the southern lake basin (Abs.): G.S.A. Annual Meeting Program, p. 23A.
- Byers, A. C., Wenzel, L. K., Laird, W. M., and Dennis, P. E., 1946, Ground water in the Fargo-Moorhead area, North Dakota and Minnesota: U.S. Geol. Survey Progress Report, 72 p.
- Clayton, Lee, Laird, W. M., Klassen, R. W., and Kupsch, W. O., 1965, Intersecting minor ridges on Lake Agassiz plain: Jour. Geology, v. 73, no. 4, p. 652-656.
- Colton, R. B., 1958, Note on the intersecting minor ridges in the Lake Agassiz basin, North Dakota, in Guidebook, Ninth Annual Field Conference, Mid-Western Friends of the Pleistocene: North Dakota Geol. Survey Misc. Series, no. 10, p. 74-77.
- Colton, R. B., Lemke, R. W., and Lindvall, R. M., 1963, Preliminary glacial map of North Dakota: U.S. Geol. Survey Misc. Geol. Inv. Map I-331.
- Dennis, P. E., Akin, P. D., and Worts, G. F., Jr., 1949, Geology and ground-water resources of parts of Cass and Clay Counties, North Dakota and Minnesota: North Dakota State Water Comm. Ground Water Studies, no. 10, 177 p.
- Dennis, P. E., Akin, P. D., and Jones, S. L., 1950, Ground water in the Kindred area, Cass and Richland Counties, North Dakota: North Dakota State Water Comm. Ground Water Studies, no. 11, 75 p.
- Elson, J. A., 1957, Lake Agassiz and Mankato-Valders problem: Science, v. 126, no. 3281, p. 99-102.
- Elson, J. A., 1961, Soils of the Lake Agassiz basin, in Leggett, R. F., Soils in Canada, geological, pedological, and engineering studies: Royal Soc. Canada Spec. Pub. 3, p. 51-79.
- Fenneman, N. M., 1938, Physiography of eastern United States: New York, McGraw-Hill Book Co.
- Flint, R. F., 1928, Eskers and crevasse fillings: American Jour. Sci., v. 15, p. 410-416.
- 1953, Glacial geology and the Pleistocene Epoch: New York, John Wiley and Sons, 589 p.
- 1955, Pleistocene geology of eastern South Dakota: U.S. Geol. Survey Prof. Paper 262, 173 p.
- Hainer, J. L., 1956, Geology of North Dakota: North Dakota Geol. Survey Bull. 31, 46 p.
- Hall, C. M., and Willard, D. E., 1905, Casselton-Fargo folio no. 117: U.S. Geol. Survey Atlas, 8 p.
- Holmes, C. D., 1957, Kames: Am. Jour. Sci., v. 245, p. 240-249.
- Horberg, Leland, 1951, Intersecting minor ridges and periglacial features in the Lake Agassiz basin, North Dakota: Jour. Geology, v. 59, no. 1, p. 1-18.
- Johnston, W. A., 1916, The genesis of Lake Agassiz: A confirmation Jour. Geology, v. 24, no. 7, p. 625-638.
- Kelly, T. E., 1964, Geology and ground water resources of Barnes County, North Dakota; Part II, Ground water basic data: North Dakota Geol. Survey Bull. 43 and North Dakota State Water Comm. County Ground Water Studies 4, 156 p.
- Klausing, R. L., 1966, Geology and ground water resources of Cass County, North Dakota; Part II, Ground water basic data: North Dakota Geol. Survey Bull. 47 and North Dakota State Water Comm. County Ground Water Studies 8, 157 p.
- Knoble, E. W., Peightal, M. F., and Chapman, J. E., 1924, Soil survey of Cass County, North Dakota: U.S. Dept. of Agriculture Bull. 29, ser. 1924, 80 p.
- Lemke, R. W., 1960, Geology of the Souris River area: U.S. Geol. Survey Prof. Paper 325, 138 p.
- Lemke, R. W., and Colton, R. B., 1958, Summary of the Pleistocene geology of North Dakota, in Guidebook, Ninth Annual Field Conference, Mid-Western Friends of the Pleistocene: North Dakota Geol. Survey Misc. Series, no. 10, p. 41-57.
- Lemke, R. W., Laird, W. M., Tipton, M. J., and Lindvall, R. M., 1965, Quaternary geology of the Northern Great Plains, in the quaternary of the United States -- a review volume for the VII Congress of the International Assoc. for Quaternary Research: Princeton Univ. Press, 922 p.
- Leverett, Frank, 1912, Early stages and outlets of Lake Agassiz, in Sixth Biennial Report of the Director of the Agricultural College Survey of North Dakota, p. 18-28.
- Leverett, Frank, with contr. by Sardeson, F. W., 1932, Quaternary geology of Minnesota and parts of adjacent states: U.S. Geol. Survey Prof. Paper

161, 149 p.

- Nikiforoff, C. C., 1952, Origin of microrelief in the Lake Agassiz basin: *Jour. Geology*, v. 60, p. 99-103.
- Omodt, H. W., Patterson, D. S., and Olson, O. P., 1961, General soil map of North Dakota: Agricultural Experiment Station, Fargo, N. Dak.
- Simpson, H. E., 1929, Geology and ground-water resources of North Dakota: U.S. Geol. Survey Water-Supply Paper 598, 311 p.
- Thwaites, F. T., 1961, Outline of glacial geology: Ann Arbor, Mich., Edwards Bros. Inc., 142 p.
- U.S. Weather Bureau, 1940-1964, Climatological data for North Dakota: *Ann. Summary 1939-1963*.
- Upham, Warren, 1895, The glacial Lake Agassiz: U.S. Geol. Survey Mon. 25, (1896), 658 p.
- Willard, D. E., 1909, Jamestown-Tower folio no. 168: U.S. Geol. Survey Atlas, 11 p.
- Winters, H. A., 1963, Geology and ground water resources of Stutsman County, North Dakota; Part I, Geology: North Dakota Geol. Survey Bull. 41 and North Dakota State Water Comm. County Ground Water Studies 2, 84 p.

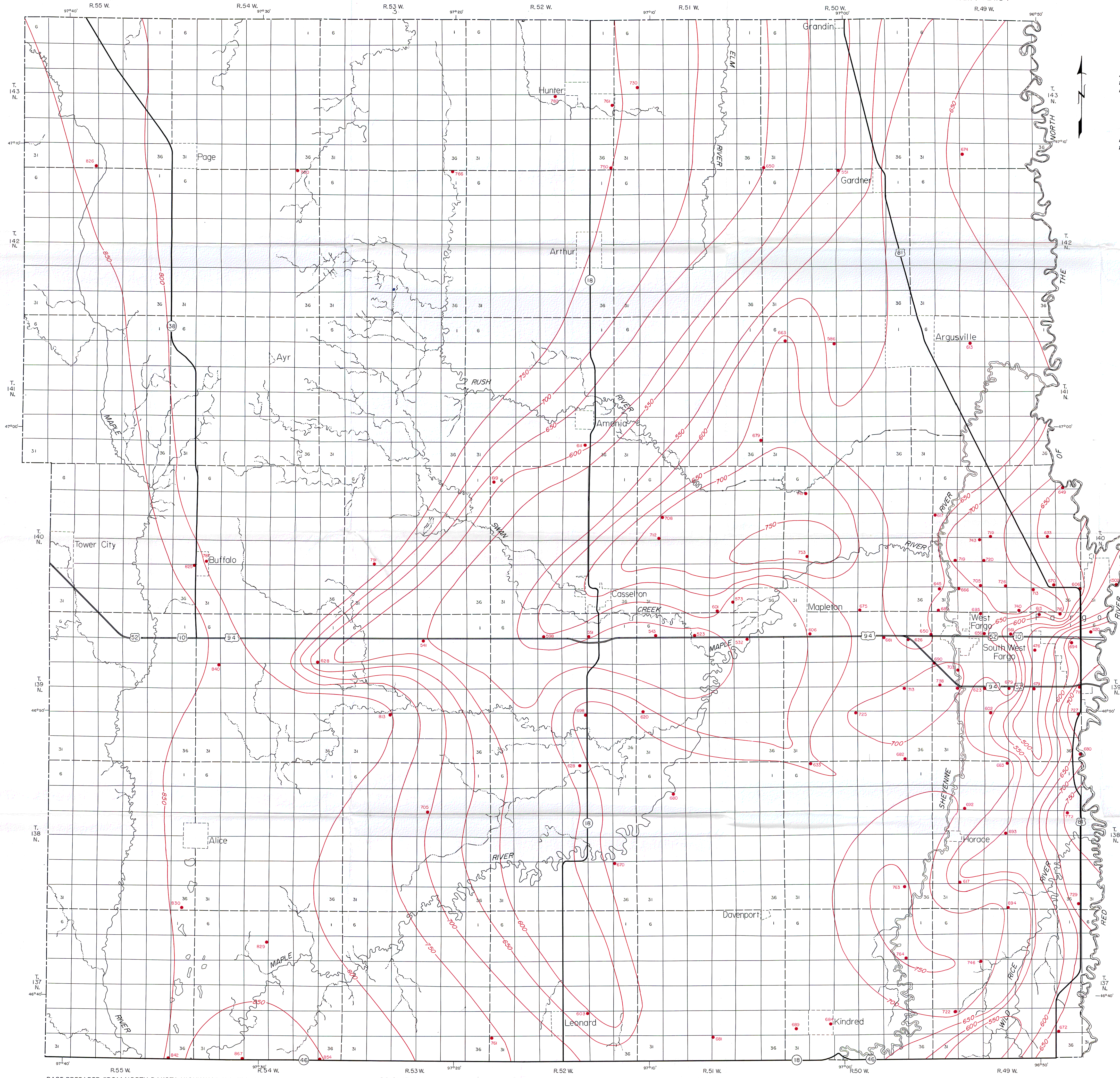

EXPLANATION

—700—
 Bedrock contour

Shows altitude of bedrock surface. Con-
 tour interval 50 feet. Datum is mean sea
 level

•613
 Control point

Number is altitude of bedrock surface, in
 feet above mean sea level

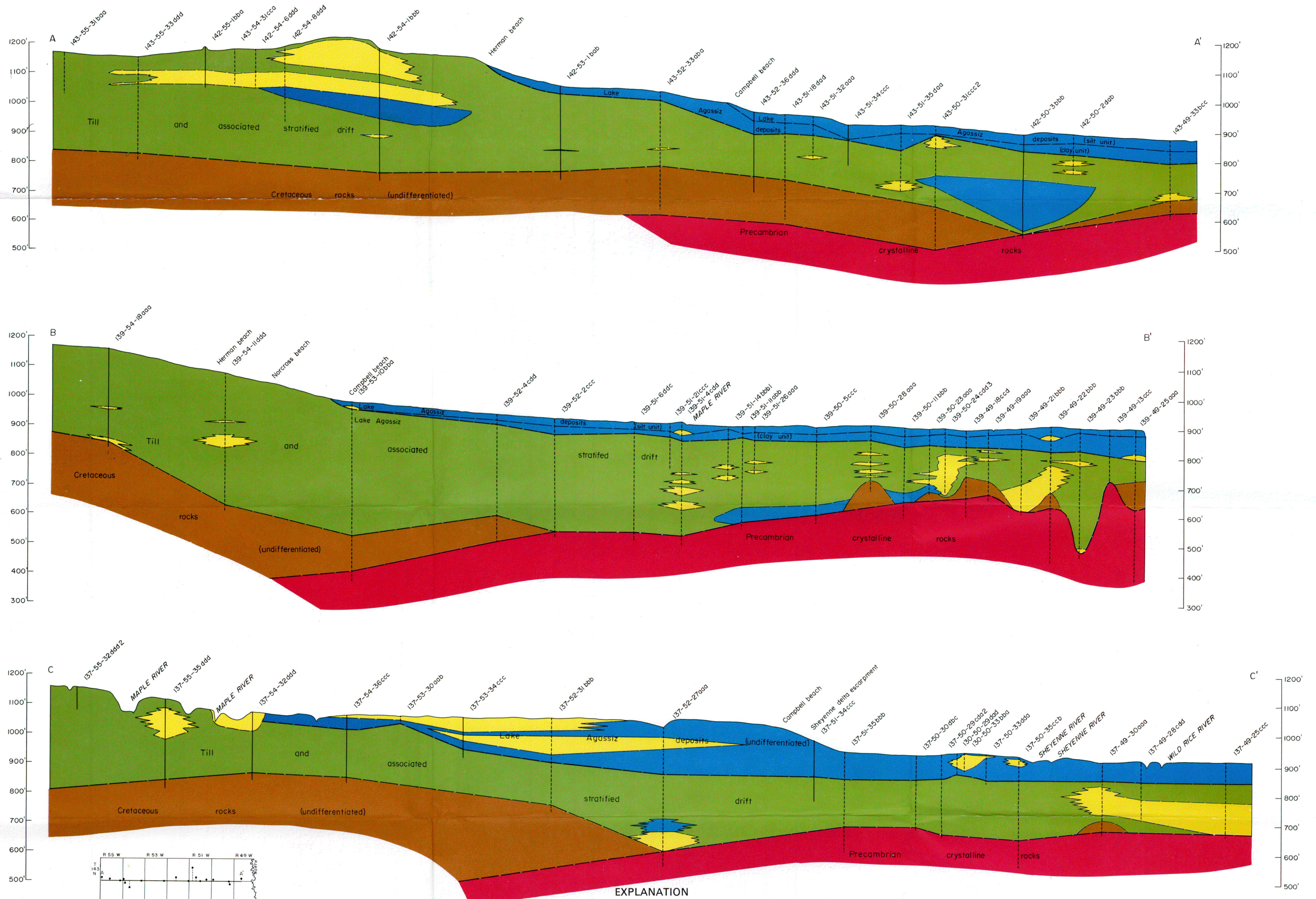

EXPLANATION

- Clay and silt
- Till
- Sand and gravel
- Shale and (or) sandstone
- Weathered crystalline rocks

0 1 2 3 Miles
 Scale
 Datum is mean sea level
 Vertical exaggeration x 53

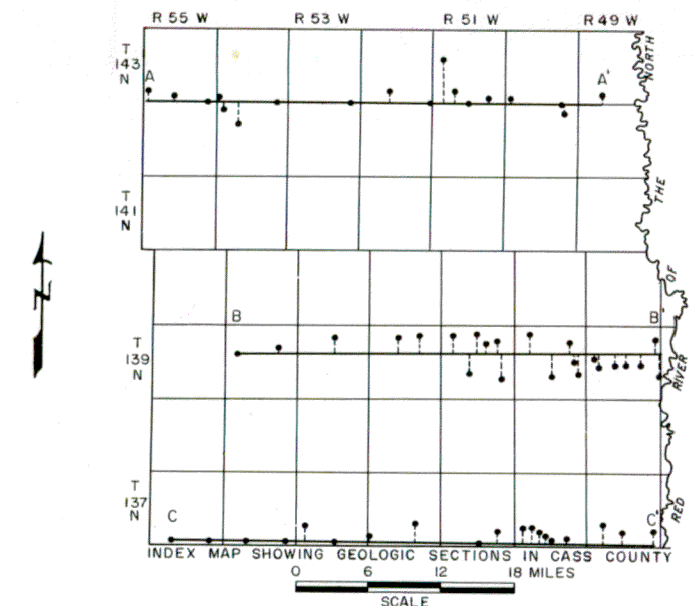
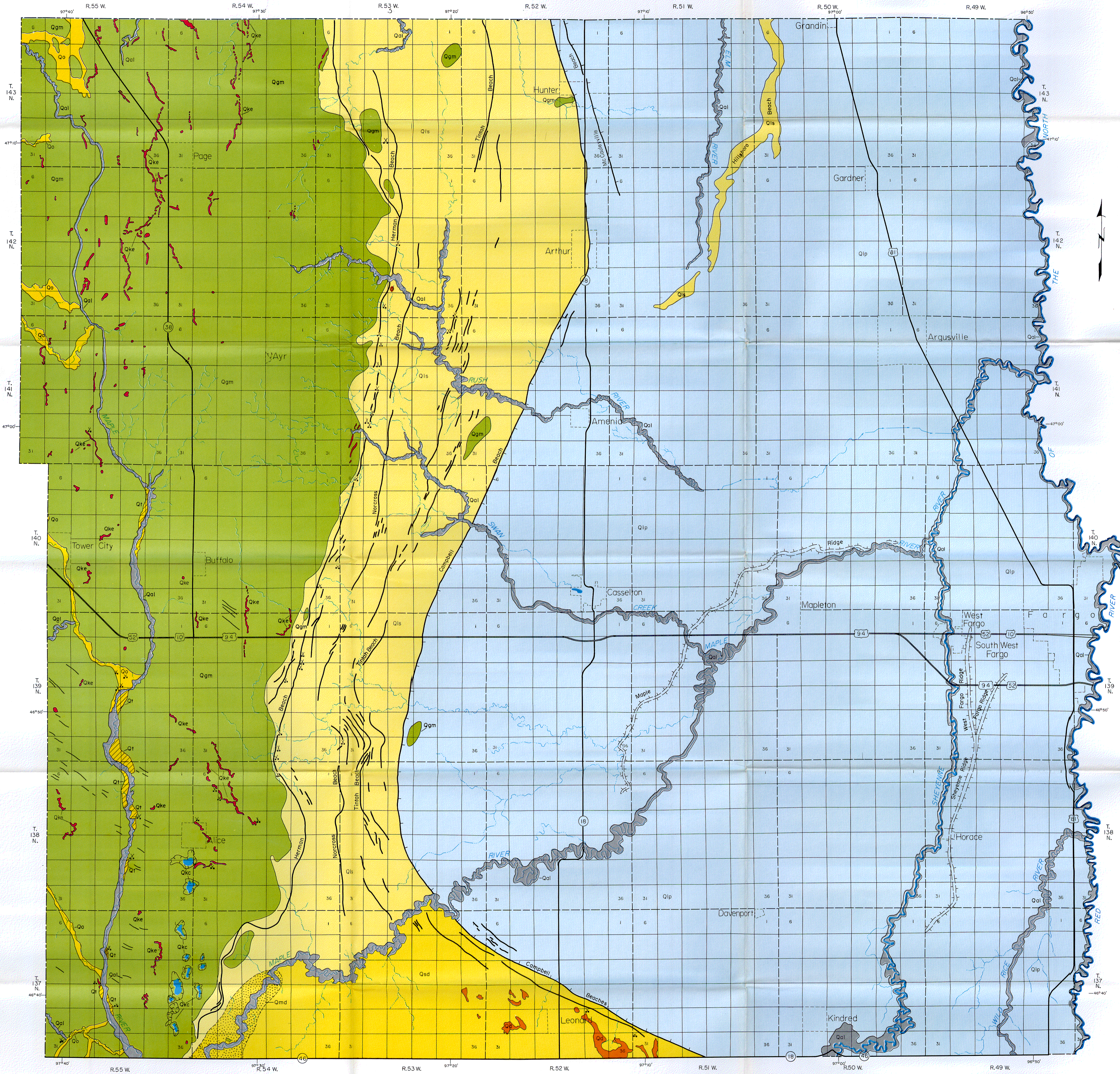

PLATE 2.—GEOLOGIC SECTIONS IN CASS COUNTY, NORTH DAKOTA



EXPLANATION

(Deposits are almost contemporary in age; units arranged approximately in order of deposition)

Qal
ALLUVIUM
 Sand, silt, and clay underlying flood plains of major streams. Known maximum thickness 15 feet

Qd
DUNE SAND
 Silt to fine sand in low dunes; not mapped where too thin to form distinct dune topography. Gradational contact with Sheyenne delta deposits (Qsd)

Qls
SHORE DEPOSITS
 Sorted and stratified deposits of gravel, sand, silt, and clay; range in thickness from 0 to about 15 feet

Qlp
LAKE-PLAIN DEPOSITS
 Consists of two units: upper unit is a silty, yellow clay that ranges in thickness from 0 to about 50 feet; lower unit is a silty, olive-gray, plastic clay that ranges in thickness from 0 to about 80 feet

Qsd
SHEYENNE DELTA DEPOSITS
 Well-sorted deposits of thinly laminated silt and fine to medium sand. Range in thickness from 0 to about 120 feet

Qmd
MAPLE DELTA DEPOSITS
 Deposits of sand and gravel ranging in thickness from 0 to about 50 feet. Finer sediments cannot be differentiated from adjacent deposits

TILL AND ASSOCIATED STRATIFIED DRIFT DEPOSITS

Qo
OUTWASH CHANNELS AND ASSOCIATED DEPOSITS
 Linear bodies of gravel, sand, silt, and clay deposited by glacial melt water in channels either in the till or on thin stagnant ice. The deposits range in thickness from 0 to about 25 feet

Qt
TERRACE DEPOSITS
 Poorly bedded terrace deposits of sand and gravel in the Maple River valley. Range in thickness from 0 to about 20 feet

Qke
KAMES AND ESKERS
 Mounds and sinuous ridges ranging from 10 to 40 feet in height, and consisting chiefly of poorly sorted silt, sand, gravel, and minor amounts of till. Maximum known thickness about 20 feet

Qgm
GROUND MORAINE
 Gently rolling terrain underlain by clayey till that ranges in thickness from 270 to 470 feet. Local relief generally less than 25 feet. Surficial deposits are of Late Wisconsin age

CREST OF BEACH RIDGE

KETTLE CHAIN
 Isolated depressions and groups of depressions in till, as much as 25 feet deep. Linear trend

WAVE-CUT SLOPE

GEOLOGIC CONTACT, DASHED WHERE INFERRED

WASHBOARD MORAINES
 Low ridges composed of till 10 to 15 feet high

SAND AND GRAVEL PIT

MAPLE AND SHEYENNE RIDGES
 Long ridges, 5 to 20 feet high. Consist of silty, gray clay underlain by sand and gravel

DRAIN

BASE PREPARED FROM NORTH DAKOTA HIGHWAY DEPARTMENT COUNTY HIGHWAY MAPS

0 1 2 3 MILES
 SCALE

GEOLOGY BY R. L. KLAUSING

PLATE 3.—SURFICIAL GEOLOGIC MAP OF CASS COUNTY, NORTH DAKOTA