

MIGRATION OF CONTAMINANTS FROM BURIED OIL-AND-GAS
DRILLING FLUIDS WITHIN THE GLACIAL SEDIMENTS
OF NORTH-CENTRAL NORTH DAKOTA

By

William A. Beal
International Technology Corporation
Baton Rouge, Louisiana

Edward C. Murphy
North Dakota Geological Survey
Grand Forks, North Dakota

Alan E. Kehew
Western Michigan University
Kalamazoo, Michigan

Report of Investigation No. 86
North Dakota Geological Survey
Sidney B. Anderson,
Acting State Geologist

BEAL, WILLIAM A., MURPHY, EDWARD C., KEHEW, ALAN E.--MIGRATION OF CONTAMINANTS FROM BURIED OIL-AND-GAS DRILLING FLUIDS WITHIN THE GLACIAL
SEDIMENTS OF NORTH-CENTRAL NORTH DAKOTA--North Dakota Geological Survey R.I. No. 86

MIGRATION OF CONTAMINANTS FROM BURIED OIL-AND-GAS
DRILLING FLUIDS WITHIN THE GLACIAL SEDIMENTS
OF NORTH-CENTRAL NORTH DAKOTA

By

William A. Beal
International Technology Corporation
Baton Rouge, Louisiana

Edward C. Murphy
North Dakota Geological Survey
Grand Forks, North Dakota

Alan E. Kehew
Western Michigan University
Kalamazoo, Michigan

Report of Investigation No. 86
North Dakota Geological Survey
Sidney B. Anderson,
Acting State Geologist

CONTENTS

| | Page |
|--|------|
| ABSTRACT | viii |
| ACKNOWLEDGMENTS | ix |
| INTRODUCTION | 1 |
| Description of Problem | 1 |
| Drilling Fluid | 2 |
| Drilling Fluid Disposal and Pit Reclamation | 4 |
| Previous Work | 4 |
| Study Sites | 6 |
| Climate | 6 |
| Objectives | 7 |
| METHODS | 7 |
| Field Methods | 7 |
| Laboratory Methods | 10 |
| GEOLOGY OF NORTH-CENTRAL NORTH DAKOTA | 11 |
| GROUNDWATER RESOURCES OF NORTH-CENTRAL NORTH DAKOTA | 12 |
| J. J. WINDERL #1 | 12 |
| Introduction | 12 |
| Local Geology and Geohydrology | 13 |
| Apparent Resistivity | 14 |
| Groundwater Chemistry | 15 |
| Density Stratification of Contaminant | 20 |
| Contaminant Migration | 20 |
| Contaminant in Till | 24 |
| Interpreted Resistivity | 25 |
| Conclusions | 27 |
| FOSSUM FEDERAL #4 | 28 |
| Introduction | 28 |
| Geology | 28 |
| Geohydrology | 29 |
| Apparent Resistivity | 31 |
| Groundwater Chemistry | 32 |
| Saturated-Paste Extract | 33 |
| Contaminant Migration in Till | 35 |
| Conclusions | 37 |
| RECOMMENDATIONS | 37 |
| PRESENT STATUS OF DRILLING FLUID DISPOSAL IN NORTH DAKOTA | 38 |
| REFERENCES | 40 |

ILLUSTRATIONS

| Figure | Page |
|--|------|
| 1. The boundaries of the Williston Basin (from Anderson and Bluemle, 1984) | .1 |
| 2. Oil-and-gas fields of North Dakota (from Bluemle and Fischer, 1986) | .1 |
| 3. Location of the two study sites | .6 |
| 4. Piezometer and lysimeter profiles as installed in this study. | .8 |
| 5. Installing piezometers at the Winderl site (L., Ed Murphy, R., Dave Lechner) | .9 |
| 6. David O. Lechner obtaining groundwater samples from a Winderl piezometer | .9 |
| 7. Configuration of the four electrode array used in the electrical earth resistivity surveys. | 10 |
| 8. Geologic map of the study areas (modified from Moran and others, 1985) | 12 |
| 9. Topographic map of a portion of the Glenburn field in Renville County | 13 |
| 10. The J. J. Winderl #1 study site, Renville County. Photo taken looking due North | 15 |
| 11. The J. J. Winderl #1 study site, Renville County. Photo taken looking west-northwest. | 15 |
| 12. Map view of the Winderl site depicting the location of water sampling instrumentation and Shelby-tube holes. | 16 |
| 13. Geologic fence diagram of the Winderl site | 16 |
| 14. Water table maps of the Winderl site (October, 1984 to November, 1986). | 17 |
| 15. Apparent iso-resistivity maps of the Winderl site for electrode spacings of 3, 5, 8, 10, 12, 16, 20, 24, 30, 40, 60, 80, and 100 feet (0.9, 1.5, 2.4, 3.1, 3.7, 4.9, 6.1, 7.3, 9.1, 12.2, 15.2, 18.3, 24.4, and 30.5 m). | 17 |

| | | |
|-----|---|----|
| 16. | Isoconcentration maps for major ions and trace metals within the meltwater channel at the Winderl site | 18 |
| 17. | Monthly precipitation (in inches) for 1984-1986 at a recording station (Foxholm) near the study site. | 20 |
| 18. | Total dissolved solids, chloride, sulfate, magnesium, and calcium concentration profiles for piezometers 6 and 7 | 22 |
| 19. | Total dissolved solids, chloride, sulfate, barium, and zinc concentration profiles for piezometers 30, 31, and 32 | 22 |
| 20. | Location map of the Winderl site and the Spring Coulee Creek meltwater channel and isoconcentration maps of TDS, Cl, Na, Ca, SO ₄ , As, Ba, and Zn within the Spring Coulee Creek Aquifer. | 23 |
| 21. | Hypothetical breakthrough curves at the Winderl site for the transport of non-reactive solutes at dispersivities of 1 m, 25 m, and 100 m.. . . . | 24 |
| 22. | Profiles of piezometer installation at the Winderl site | 26 |
| 23. | Lithologic column and chloride concentration profiles for the eight piezometer nests at the Winderl site | 26 |
| 24. | Northeast-southwest and northwest-southeast cross sections of Dar-Zarrouk interpreted resistivity and isoconcentration map | 27 |
| 25. | The Fossum Federal #4 study site, Bottineau County. Photo taken looking north-northeast. | 30 |
| 26. | The Fossum Federal #4 study site, Bottineau County. Photo taken looking north-northeast. | 30 |
| 27. | Map view of the Winderl site depicting groundwater and porewater instrumentation and Shelby tube hole locations. | 31 |
| 28. | Geologic fence diagram of the Fossum study site | 31 |

| | | |
|-----|---|----|
| 29. | United States Department of Agriculture textural classification of the till samples from the Fossum site | 32 |
| 30. | Potentiometric maps of the till unit at the Fossum site (October, 1984 to June, 1985) | 34 |
| 31. | Apparent iso-resistivity maps of the Fossum site at electrode spacings of 3, 5, 8, 10, 12, 16, 20, 24, and 30 feet (0.9, 1.5, 2.4, 3.1, 3.7, 4.9, 6.1, 7.3, and 9.1 m) | 34 |
| 32. | Isoconcentration maps of TDS, Cl, Na, Ca, Mg, and SO ₄ from groundwater at a depth of 35-45 feet (10.7-13.7 m) below the surface at the Fossum site | 35 |
| 33. | Isoconcentration maps of TDS, Cl, Na, Ca, Mg, and SO ₄ from groundwater at a depth of 60 feet (18.3 m) below the surface at the Fossum site | 35 |
| 34. | Chemical ion profiles for three lysimeter and piezometer nests (A, B, and C) at the Fossum site | 36 |
| 35. | Electrical conductivity and ion profiles from saturated paste extract data obtained from Shelby tube sediments | 36 |
| 36. | A fence diagram of chloride concentrations ob- tained from saturated paste extracts | 36 |
| 37. | W. A. Beal performing falling head tests at the Fossum #4 | 37 |

| | | |
|-------|--|------|
| Table | | Page |
| 1. | Function and general purpose of drilling fluid additives (from Murphy and Kehew, 1984) | 3 |
| 2. | High, low, and mean of brines in the Glenburn Field | 14 |
| 3. | TDS, Cl, and NO ₃ concentrations in groundwater adjacent to the 1959 and 1980 drilling mud and normal levels of these ions in groundwater | 19 |
| 4. | Trace metal concentrations (in g/l) of chromium, lead, and arsenic in shallow groundwater at the Winderl site | 21 |
| 5. | Comparison of TDS, Cl, Na, SO ₄ , and NO ₃ in three farm wells downgradient from the Winderl site | 25 |

| | |
|---|----|
| 6. Chemical analyses of brines from the Madison Formation in the Wylie Field, Bottineau County. | 29 |
| 7. X-ray diffraction analyses of clay samples from till at the Fossum site | 33 |
| 8. Methods of drilling fluid disposal. | 39 |

ABSTRACT

A common practice during oil and gas well-site reclamation in North Dakota is to bury the drilling muds in shallow trenches near the borehole. These muds are salt-water based (between 100,000 and 300,000 mg/l of NaCl) and can contain high concentrations of chromium, lead, and other toxic trace metals.

Two reclaimed oil and gas well sites were chosen for study in north-central North Dakota: the Winderl site in southeastern Renville County, and the Fossum site in west-central Bottineau County. The Winderl oil well was drilled in 1959, and the drilling fluids were disposed of in a shallow pit excavated in Pleistocene glaciofluvial deposits. The Fossum oil well was drilled in 1978 and the drilling fluids were disposed of in trenches excavated in Pleistocene till.

A total of 41 shallow piezometers (maximum depth is 62 feet {18.9 m}) and 13 pressure-vacuum lysimeters were installed in and around the two disposal sites to obtain groundwater and pore-water samples. Vertical electrode sounding resistivity profiles were conducted at both sites utilizing 14 electrode spacings down to a depth of 100 feet (30.5 m). Sediment samples were obtained with Shelby tubes for X-ray fluorescence and X-ray diffraction analyses. Additional chemical analyses were performed on saturated-paste extracts from the Shelby-tube samples.

The results of chemical analyses of porewater, groundwater, saturated-paste extracts, and the earth resistivity surveys indicate that leachate is being generated from buried drilling fluid at both study sites. At the Winderl site, contaminants have migrated beyond 400

feet (122 m), the extent of the monitored area, which has resulted in degradation of the Spring Coulee Creek Aquifer. A one-dimensional analytical solute transport equation was utilized to illustrate the potential for contaminant migration at the site. The equation predicts high concentration of contaminants over 3,300 feet (1,000 m) from the source area.

Contaminant migration within the till at the Fossum site is believed to occur along fractures directly below the water table. The estimated groundwater velocity through these fractures is 3.8 m/day (12.8 ft/day) compared to 7.2×10^{-7} m/day (2.4×10^{-6} ft/day) estimated for the till matrix. However, it has been reported that molecular diffusion is an important retardation mechanism that reduces the concentration of contaminants along these fractures with distance from the source. Also, the fractures constitute a small volume of pore space; therefore, the quantity (or flux) of water flowing along the fractures is small.

Disposal of drilling fluids in glaciofluvial sediments is not recommended. The study at the Winderl site is evidence of the adverse environmental impact such disposal can lead to. The impact of drilling fluid disposal in till is dependent upon the geologic setting. Migration of the drilling fluid constituents will occur along fractures in the till; widespread contamination could result if these contaminants intersect permeable lenses. A subsurface investigation is necessary at the disposal sites in till to identify these permeable lenses and to determine if any nearby aquifers exist.

ACKNOWLEDGMENTS

William A. Beal wrote a Master's thesis at the University of North Dakota (1986) based upon water analysis obtained on October, 1984 from the two North-Central study sites. This report includes much of this original work and incorporates water analyses from June of 1985 and November of 1986. Several new piezometers were installed at the two sites during November of 1986 to obtain additional information and to test some of Beal's (1986) interpretations.

The 1986 piezometer installation and fieldwork was paid for by the North Dakota Geological Survey. The North Dakota State Department of Health performed the water analyses. We would like to thank Rick Nelson, Rod Reetz, and Ken Kary (NDS DH) for their assistance with the 1986 portion of this project.

The following are William A. Beal's thesis acknowledgments:

This research was supported by North Dakota Water Resources Research Institute Grant No. 5850-4138-6671 through the North Dakota Mining and Mineral Resources Research Institute.

I would like to thank my committee chairman Dr. Alan E. Kehew, and committee members Dr. John Reid and Dr. Gerald H. Groenewold. They were very cooperative and went out of their way to ensure the successful completion of this project.

I especially appreciate the efforts of Edward C. Murphy, the project Principal Investigator. His support, guidance, and friendship were invaluable.

The North Dakota Geological Survey provided vehicle support, including a truck-mounted auger and a geophysical logging van. Mr. Kenneth L. Dorsher, a NDGS employee, drafted the diagrams, and Mr. David O. Lechner, also of the NDGS, helped with the fieldwork and conducted the textural analyses.

I would like to thank Mrs. Marie Weber for allowing me to study the Winderl site. I also wish to thank Mr. Roy Johnson of the North Dakota State University Development Foundation for allowing access to the Fossum Farm, and Mr. Randy Brant, who is renting the area around the Fossum study site. I would also like to acknowledge the cooperation of Chevron, U.S.A., Inc.

I would like to thank Dr. Eugene C. Doll and Dr. Nyle Wollenhaupt for analyzing sediment samples at the North Dakota State University Land Reclamation Research Center in Mandan.

Finally, I express my deepest thanks to my parents and family. Without their support and encouragement, I never would have been able to obtain my graduate degree.

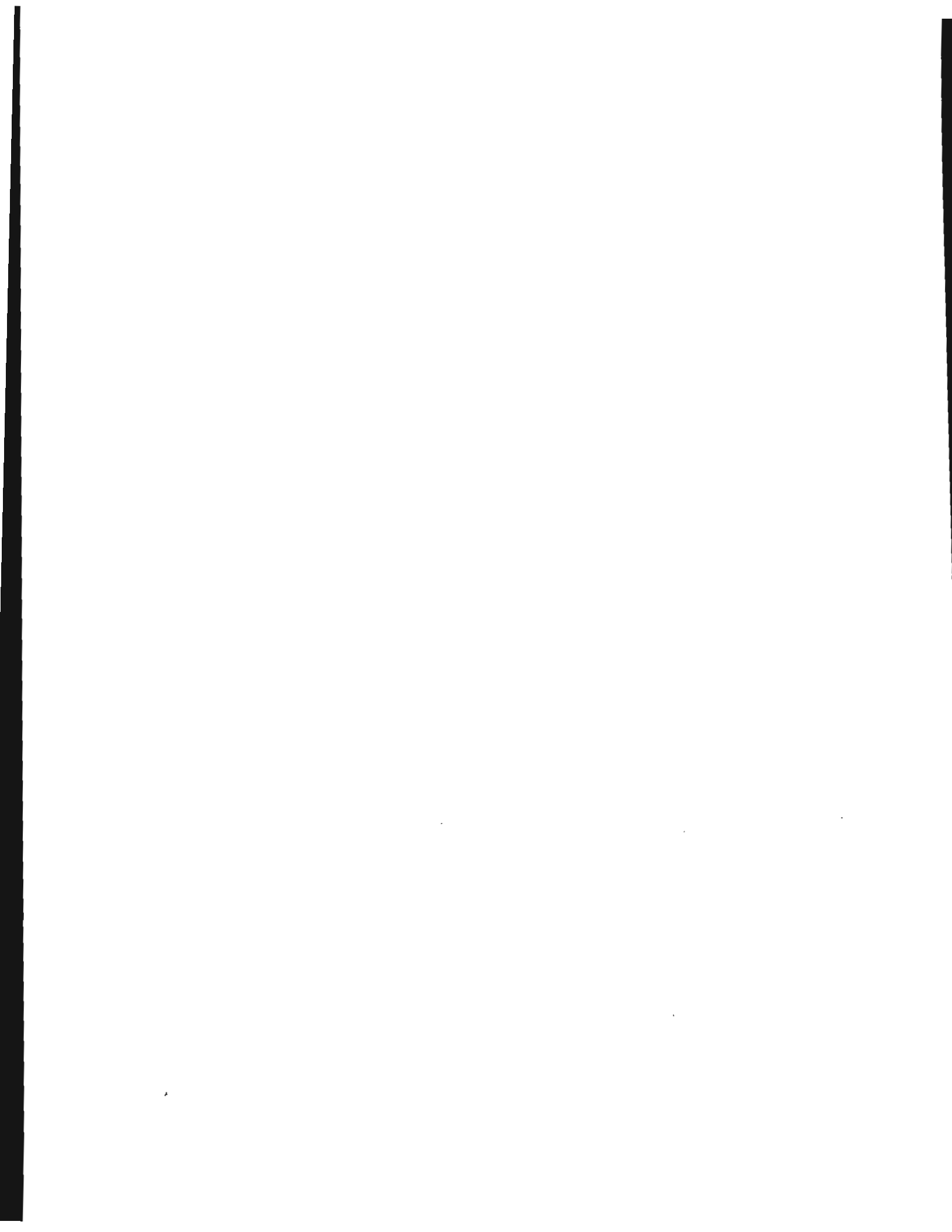

INTRODUCTION

Description of Problem

North Dakota's oil and gas production is derived from the Williston Basin--a structural and sedimentary basin located in a portion of North Dakota, South Dakota, Montana, and southern Canada (fig. 1). Since oil was

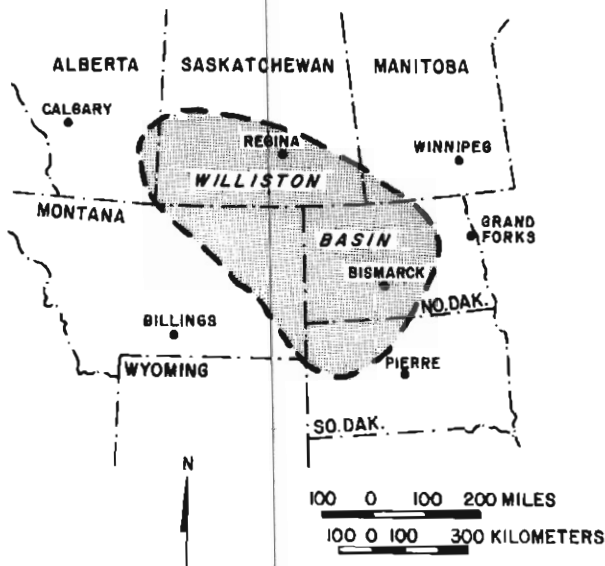

Figure 1. The boundaries of the Williston Basin (from Anderson and Bluemle, 1984).

first discovered in North Dakota in 1951, approximately 11,000 wells have been drilled in the western and north-central portions of the state (fig. 2). During the 1981-83 biennium, taxes collected on oil and gas production became North Dakota's single most important tax revenue (Anderson and Bluemle, 1984). The oil and gas production tax dropped to second and third, below income and sales tax, during 1984 and 1985 (Fischer and Bluemle, 1986). This drop was due to the decline in oil and gas prices and a 60 percent reduction in the number of wells drilled during 1986 in comparison to the previous year (200 vs. 508).

A problem inherent to the oil

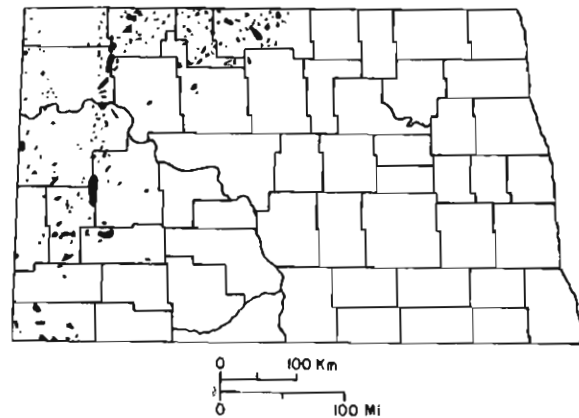

Figure 2. Oil and gas fields of North Dakota (from Fischer and Bluemle, 1986).

industry is the disposal of wastes associated with the drilling process. One such waste is drilling mud, a viscous fluid used during well drilling. A common practice during well-site reclamation is to dispose of drilling muds in shallow trenches and pits near the borehole. Murphy and Kehew (1984) conducted a study of the subsurface migration of drilling-fluid waste components beneath these buried disposal pits. The results of that study indicate that most of the hazardous constituents are attenuated within the unsaturated zone. However, other contaminants such as Na, Ca, and Cl move rapidly through the unsaturated zone and into the groundwater flow system (Murphy and Kehew, 1984).

The disposal sites monitored by Murphy and Kehew (1984) are in western North Dakota and underlain by poorly indurated clayey bedrock or sediments derived from the bedrock. The lithologic and hydrologic properties of these sediments significantly decrease the potential for movement of contaminants in the subsurface. Therefore, the authors suggested further study in areas of North Dakota that have a greater potential for groundwater contamination.

In 1983, the North Dakota Water Resources Research Institute (NDWRRI)

funded a multi-phase study of the detrimental effects of oil-field brines and drilling fluids on soils and groundwater. One phase of that study, and the subject of this report, deals with groundwater contamination from drilling-fluid disposal pits. The study stems from the earlier work of Murphy and Kehew, and focuses the research on the glaciated plains of north-central North Dakota. This area differs hydrogeologically from the western North Dakota sites in the following aspects: (1) higher water table (thinner unsaturated zone), (2) presence of sandy permeable sediments, and (3) higher annual precipitation. The potential for migration of leachate and subsequent degradation of groundwater is much greater in this hydrogeologic setting.

Drilling Fluid

During the drilling of an oil and gas well, a fluid (drilling mud) is circulated down the center of the drill pipe, through the drill bit, and back up to the surface. Rock cuttings, brought up with the fluid, are separated at the shale shaker and the drilling mud is recirculated down the drill pipe. In addition to transporting the cuttings, the drilling fluid must perform the following functions: (1) control formation pressures, (2) maintain borehole stability, (3) protect productive formations, (4) protect against corrosion, and (5) cool and lubricate the bit and drill stem (Simpson, 1975).

Types of drilling fluid include water-base fluids, oil-base fluids, low-solid polymer fluids, and oil-emulsion fluids. However, 89-95 percent are either freshwater or salt-water based (Mosely, 1983). The freshwater muds generally are colloidal slurries that contain bentonite clay. If salt water is used, attapulgite clay (Fuller's earth) commonly is substituted for bentonite, because sodium bentonite will flocculate

and not form a satisfactory colloid in salt water (Gatlin, 1960, p. 81).

Simple colloidal mixtures of clay and water are usually insufficient if the drilling fluid is to perform all the required functions. Therefore, minerals and chemicals are added to modify fluid properties in response to subsurface drilling conditions. Approximately 100,000 tons of inorganic chemical additives are used every year by the oil and gas industry (Musser, 1985). Table 1 lists the common drilling additives and their respective functions.

In the Williston Basin, most of the oil is produced from Paleozoic carbonate units that lie beneath a series of halite beds. Salt (NaCl) must be included in the drilling fluids to prevent dissolution of the halite and subsequent loss of circulation during drilling. A typical well in North Dakota is drilled with freshwater until the surface casing is set. At that time, either salt is added to the mud or freshwater is replaced by produced water (brine) (Murphy and Kehew, 1984). The concentration of salt in drilling fluids is reported to be between 100,000 and 300,000 mg/l (Murphy and Kehew, 1984; Dewey, 1984). Produced waters commonly contain high concentrations of ions other than sodium and chloride. These ions also will be present in the drilling muds that utilize brines for their salt-water base. There are areas in North Dakota where a well does not encounter any evaporite beds above a producing horizon. In these areas the mud is generally gypsum based and can have a salt content of 40,000-100,000 mg/l.

As drilling progresses, chemical and mineral additives are incorporated into the drilling fluids (e.g., starches, NO_3^- , CrO_4^{2-} see table 1). Subsurface drilling conditions in North Dakota can vary significantly; as a result, the nature and concentration of these additives will vary as well. The types

Table 1. Function and general purpose of drilling fluid additives (from Murphy and Kehew, 1984).

| Function | General Purpose | Common Additives |
|---------------------------|---|---|
| Weighting Material | Control formation pressure, check caving, facilitate pulling dry pipe, & well completion operations | Barite, lead compounds, iron oxides |
| Viscosifier | Viscosity builders for fluids, for a high viscosity-solids relationship | Bentonite, attapulgite clays, all colloids, fibrous asbestos |
| Thinner Dispersant | Modify relationship between the viscosity and percentage of solids, vary gel strength, deflocculant | Tannins (quebracho), polyphosphates, lignitic materials |
| Filtrate Reducer | Cut the loss of the drilling fluid's liquid phase into the formation | Bentonite clays, sodium carboxymethyl cellulose (CMC), pregelatinized starch, various lignosulfonates |
| Lost Circulation Material | Primary function is to plug the zone of loss | Walnut shells, shredded cellophane flakes, thixotropic cement, shredded cane fiber, pig hair, chicken feathers, etc. |
| Alkalinity, pH Control | Control the degree of acidity or alkalinity of a fluid | Lime, caustic soda, bicarbonate of soda |
| Emulsifier | Create a heterogeneous mixture of two liquids | Lignosulfonates, mud detergent, petroleum sulfonate |
| Surfactant | Used to the degree of emulsification, aggregation, dispersion, interfacial tension, foaming, and defoaming (surface active agent) | Include additives used under emulsifier foamers, defoamers, & flocculators |
| Corrosion Inhibitor | Materials attempt to decrease the presence of such corrosive compounds as oxygen, carbon dioxide, and hydrogen sulfide | Copper carbonate, sodium chromate, chromate-zinc solutions, chrome lignosulfonates, organic acids and amine polymers, sodium arsenite |
| Defoamer | Reduce foaming action especially in salt water based muds | Long chain alcohols, silicones, sulfonated oils |
| Foamer | Surfactants which foam in the presence of water and thus permit air or gas drilling in formations producing water | Organic sodium & sulfonates, alkyl benzene sulfonates |
| Flocculants | Used commonly for increases in gel strength | Salt, hydrated lime, gypsum, sodium tetraphosphates |
| Bactericides | Reduce bacteria count | Starch preservative, paraformaldehyde, caustic soda, lime, sodium pentachlorophenate |
| Lubricants | Reduce torque and increase horsepower at the bit by reducing the coefficient of friction | Graphite powder, soaps, certain oils |
| Calcium Remover | Prevent and overcome the contamination effects of anhydrite and gypsum | Caustic soda (NaOH), soda ash, bicarbonate of soda, barium carbonate |
| Shale Control Inhibitors | Used to control caving by swelling or hydrous disintegration | Gypsum, sodium silicate, calcium lignosulfonates, lime, salt |

of additives will also be dependent upon the availability of mud components to the operators.

Completion and workover fluids are also disposed of with the drilling muds and deserve mention here. These fluids are commonly hydrochloric, formic, or acetic acids used to increase the permeability of the producing carbonate zones. The volume of these acids can vary from 500 to several thousand gallons ($\approx 1,900$ L).

Drilling Fluid Disposal and Pit Reclamation

Murphy and Kehew (1984) present a detailed description of drilling-fluid disposal and pit reclamation practices in North Dakota. Their work is summarized in this section.

The drilling-fluid pit, or reserve pit, is excavated adjacent to the drilling rig and generally has a volume of between 54,000 and 90,000 ft³ (1,500 and 2,500 m³). If the pit is constructed in permeable sediment, the Oil and Gas Regulatory Division of the North Dakota State Industrial Commission has the authority to require the operator to install an artificial or synthetic liner. This authority is granted to the Oil and Gas Division by the General Rules and Regulations for the Conservation of Crude Oil and Natural Resources, which went into effect in 1974. Prior to these rules, operators commonly would line the pits with bentonite clay to prevent seepage through permeable sediments.

During most of the drilling period, the fluid is circulated in a closed system that does not include the reserve pit. However, cuttings containing fluid coatings are deposited in the pit along with fluids that are periodically flushed out of the settling tanks. The amount of fluid permanently disposed of in the reserve pit varies. If the well is produced, all of the fluid generally will be removed from the

borehole during cementing procedures and pumped into the pit for disposal. On the other hand, if the well is plugged, it is common practice to remove only the drilling fluid displaced by the cement plugs, leaving the remainder in the borehole.

Pit reclamation begins with removal of the low viscosity portion of the fluid for use at another drilling site or disposal in an injection well. In the 1950s and 60s, reserve pits were reclaimed by simply pushing sediment into the pits from the sides. Reclamation took anywhere from a month to a year because the fluids were contained within a small area and could not desiccate rapidly. The most common reclamation procedure today incorporates a trenching method. A series of trenches is excavated on one side of the reserve pit, and sediment is pushed in from the other side forcing the drilling fluid into the trenches. The result is that fluid is spread out over a large area and reclamation can be completed in a few days simply by backfilling and leveling the pit and trenches. However, for reserve pits with synthetic liners, trenching forces the fluid out of the lined pits, and increases the chances of migration of contaminants into the groundwater flow system.

Previous Work

The U.S. Environmental Protection Agency (EPA) held a conference in 1975 on the environmental effects of chemical use in well drilling (Fisher, 1975). The purpose of this conference was to identify the potential environmental problems that could result from the increase in oil-well drilling that was occurring in the 1970s. Talks were presented on the drilling process and the purpose and nature of drilling fluids. Attention was also given to the toxicity of drilling-fluid additives, along with the

potential for groundwater contamination resulting from drilling-fluid disposal.

Drilling fluids were the subject of much concern in 1976 when Congress passed the Resource Conservation and Recovery Act (RCRA) regulating the generation and disposal of hazardous wastes. The status of drilling fluids and other low volume "low hazardous" wastes was uncertain until addressed in 1980 by the Solid Waste Disposal Act Amendments. These amendments exempted drilling fluids from RCRA until such time as EPA could show need for stricter regulation (Mosely, 1983). EPA was required to conduct a study of the wastes generated by the exploration, development, and production of oil and gas and geothermal energy and to submit a final report to Congress by October of 1982. In 1985, the Alaska Center for the Environment sued EPA for their failure to conduct this study. In response to this suit, EPA has recently issued a technical report on this waste and plans to issue a second report at the end of 1987 (EPA, 1986).

The American Petroleum Institute (API), in an attempt to justify the RCRA exemption, contracted the engineering consulting firm of Dames and Moore to study the hydrogeologic effects of drilling-fluid disposal across the United States. Dames and Moore monitored six reserve pits; one site is located in western North Dakota. Chemical analyses were performed on water samples from three wells around each disposal area--an upgradient background well and two downgradient wells. They also analyzed chemical extracts from surface and subsurface soil samples, and analyzed vegetation for chemical uptake. Results indicate that Na^+ and Cl^- are the most mobile ions leached from the pits. However, chloride levels were found to be below drinking water standards within several hundred feet of the disposal areas. Rates of migration of heavy metals were determined to be very slow and

not to constitute a health hazard (Dames and Moore, 1982).

The API also sponsored three related studies, which are listed below:

1. 1974-1978 "Effects of Drilling Fluid Components and Mixtures on Plants and Soils," Dr. Raymond Miller, Utah State University.
2. 1979-1982 "Plant Uptake and Accumulation of Metals Derived from Drilling Fluids," Dr. Darrell Nelson, Purdue University.
3. 1981 "Water Base Drilling Mud Land Spreading and Use as a Site Reclamation and Revegetation Medium," James Whitmore, Forsgren-Perkins Engineering.

A single API document summarizes these three studies in addition to the investigation conducted by Dames and Moore (Mosely, 1983).

Drilling-fluid disposal research in North Dakota began with a master's thesis by Edward Murphy that was later published by the North Dakota Geological Survey (Murphy, 1983; Murphy and Kehew, 1984). Four reclaimed disposal sites were monitored in western North Dakota in an attempt to encompass the different hydrogeologic variables of the areas. At two of the sites there are thick unsaturated zones and the saturated zone was not monitored. Nevertheless, water analyses from the unsaturated zones support the conclusion that attenuation prevents significant downward migration to the groundwater beneath the water table.

The other two sites are in hydrogeologic settings more conducive to leachate migration (i.e., more permeable sediments and higher water table). Chloride levels indicate that fluid disposal at these two sites affects the groundwater 60 to 90 metres downgradient of the buried pits. In addition, the recommended maximum permissible drinking water

standards were exceeded for Cd, Pb, and Se in the shallow groundwater beneath the disposal pits.

Another study of drilling-fluid disposal was recently conducted in the Williston Basin of western North Dakota and eastern Montana (Dewey, 1984). This study incorporated groundwater-chemistry analyses and extensive earth resistivity surveys at two buried disposal sites. Five other sites were evaluated with one to four resistivity soundings. Plumes of leachate were identified in the downgradient direction at the two sites where the groundwater was monitored. Furthermore, resistivity surveys indicated subsurface contamination at three of the other five sites; however, at these sites testing was not extensive enough to determine if buried drilling fluids were the contaminant source.

A study is scheduled to begin during the summer of 1987 to take a more detailed look at one of Dewey's sites. This study will also look at an abandoned central drilling-fluid disposal site near Fairview, Montana (Reiten; personal commun., 1987).

National conferences on drilling muds were held at the University of Oklahoma during May of 1985, 1986, and 1987. A number of case histories were presented from studies on reclaimed reserve pits and central disposal facilities. These conferences demonstrate the high degree of national interest that has been generated in the last five years concerning the environmental effects of buried drilling fluid.

Study Sites

Two buried reserve pits were selected in north-central North Dakota for the purposes of this study. The objective of site selection was to locate pits situated in two different hydrogeologic settings: one in till, the most common sediment in the area, and the other in sand and gravel, the

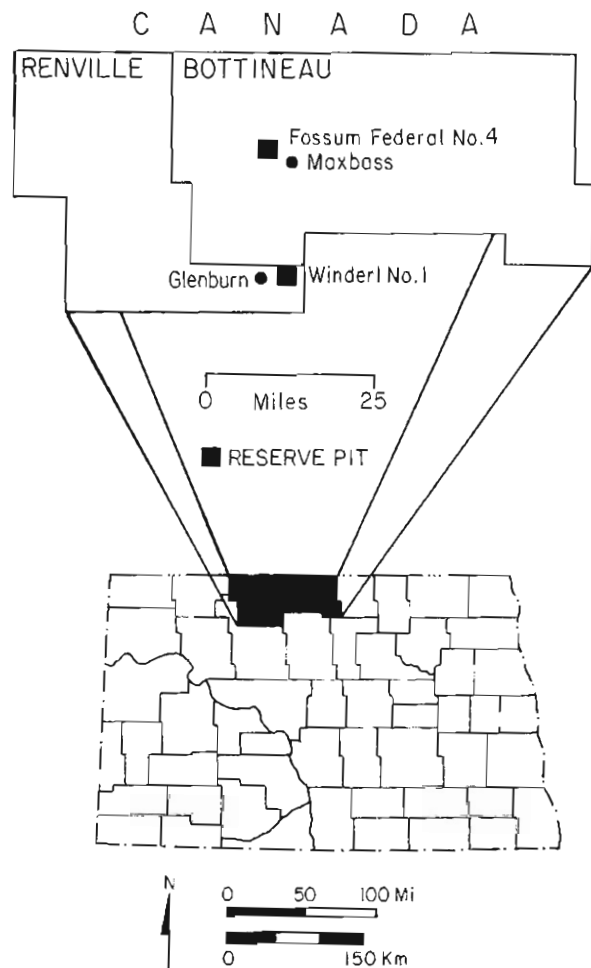

Figure 3. Location of the two study sites.

worst-case situation from a disposal standpoint. Location, accessibility, and land ownership were also considered in the selection process. The two sites chosen are the Fossom Federal #4 well in west-central Bottineau County near Maxbass, and the J.J. Winderl #1 well in southeastern Renville County near Glenburn (fig. 3).

Climate

North Dakota has a semi-arid continental climate, characterized by large seasonal variations in temperature and light to moderate precipitation (Jensen, 1972). Within the

study area, the mean annual temperature ranges from 39° to 40°F (3.9 to 4.4°C); approximately 200 days a year are below 32°F (0°C). Mean annual precipitation is around 16 inches (40.64 cm); typically 9 inches (22.86 cm) of that falls between April and July (Jensen, 1972).

Objectives

To evaluate drilling-fluid disposal in north-central North Dakota, the following objectives have been formulated for this study:

1. To determine the characteristics of the contaminant.
2. To investigate the chemical attenuation mechanisms.
3. To evaluate the distribution and extent of contamination.
4. To determine if current drilling-fluid disposal techniques are suitable for the hydrogeologic settings of north-central North Dakota.

METHODS

Field Methods

In July of 1984, piezometers were installed at the two study sites to obtain hydrologic data as well as water samples for chemical analysis. In November of 1986, additional piezometers were installed at the sites to obtain more precise groundwater data. These piezometers consist of 2-inch (5.08 cm) diameter PVC pipe connected to a 2-10 foot (0.6 to 3 m) section of slotted PVC screen. The original borings were drilled with a rotary rig and a 5.62-inch (14.27 cm) diameter bit. Air was used as the drilling fluid in well indurated or cohesive sediments. In sand and gravel, a mixture of fresh water and bentonite was circulated during drilling to stabilize the borehole. The PVC pipe and screen were installed in the

borehole and the piezometers were flushed with fresh water until the water coming up at the surface was devoid of any bentonite. The borings that were installed during 1986 were augered with the NDGS - 8-inch (20.3 cm) hollow stem auger.

The shallow piezometers at the Winderl site are screened in sand and gravel. The boreholes collapsed after these piezometers were in place and the bentonite mud was flushed out, which formed natural "gravel" packs around the screens. Washed sand or pea gravel was placed in the boreholes of the deeper piezometers (in till) at the Winderl site and at all of the piezometers at the Fossum site. The deep Winderl piezometers were sealed with 2 feet (0.61 m) of cement, and backfilled with the available cuttings. At the Fossum site, the holes were filled with cement to the ground surface (fig. 4).

In August of 1984 an air compressor was used as a "gas lift" pump to develop the piezometers. This was accomplished by pumping air into the water, causing the piezometers to flow. Pumping was continued for 30 to 45 minutes or until the water flowing at the surface was relatively clean.

Pressure-vacuum lysimeters were used to sample porewater from the unsaturated zone where the fluid pressure is below atmospheric. Each lysimeter (Soil Moisture Corp. Model 1920) consists of a 1.8-inch (4.57 cm) diameter PVC pipe, 25 inches (63.5 cm) long with a 2.5-inch (6.35 cm) porous ceramic cup at the base; both an inlet and an outlet hose extend from inside the PVC pipe through a sealed rubber stopper at the top.

The lysimeter holes were drilled with a 6-inch (15.24 cm) diameter auger provided by the North Dakota Geological Survey (fig. 5). After each lysimeter was positioned in the hole, silica flour was placed around the ceramic cup to prevent clogging of the pores; a 2-foot (0.61 m) bentonite seal

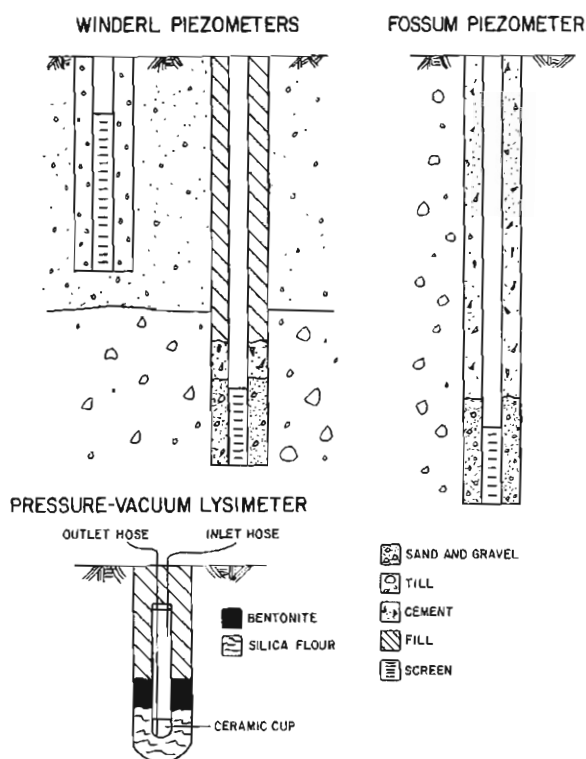

Figure 4. Piezometer and lysimeter profiles as installed in this study.

was added and the hole was backfilled with cuttings, leaving only the two hoses exposed at the surface (fig. 4).

Water samples were obtained from the monitoring equipment at the two study sites during October 1984, June 1985, and November 1986. Water samples were obtained from both the lysimeters and piezometers during the 1984 and 1985 sampling periods. In 1986, water samples were only collected from the shallow piezometers and the newly installed piezometers at the Winderl site (fig. 6). Additional samples were collected from the two recently installed piezometers at the Fossom site. To ensure representative samples, the piezometers were bailed until two well volumes had been removed. Each piezometer was allowed to recover, and a bailer was used to obtain enough sample for both major-ion and trace-

metal analysis--one litre for majors, one-half litre for trace. The temperature, pH, and electrical conductivity were measured immediately, and the sample was pumped through a 0.45-micron filter into two plastic bottles. After filtering, 5 ml of concentrated nitric acid was added to the one-half litre bottle to lower the pH and prevent precipitation of the trace metals. The bottles were placed in coolers and transported to the chemistry labs. The water samples collected during 1984 and 1985 were analyzed by a lab at North Dakota State University. The 1986 samples were analyzed by the North Dakota State Health Department.

Approximately two weeks before sampling, a vacuum was induced in each lysimeter through one of the hoses exposed at the surface. The vacuum reduced the pressure in the lysimeter below the surrounding fluid pressure, causing porewater to migrate in through the ceramic cup. Sampling was accomplished by pumping air into the inlet hose and retrieving the sample from the outlet hose. Commonly, only enough sample was available for either major-ion or trace-metal analysis. The lysimeters had a 50 percent success rate. The remainder of the sampling procedure was similar to that used for the piezometers.

Stratigraphic data and sediment samples for textural and chemical analysis were obtained from continuous Shelby-tube cores. These relatively undisturbed cores were taken with a truck-mounted, hollow-stem auger (Mobile Drill B-50) provided by the North Dakota Geological Survey. Each Shelby tube is 3 inches (7.62 cm) in diameter and 2.5 feet (0.762 m) long. Approximately 70 tubes were collected from the two study sites. In areas where sand and gravel overlie till, Shelby-tube cores of the till could not be obtained with the hollow-stem auger. In this situation, a split-tube

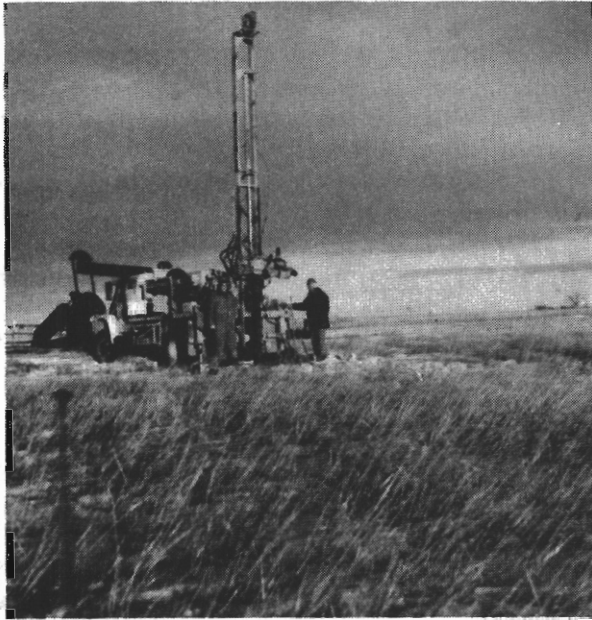

Figure 5. Installing piezometers at the Winderl site (L., Pat Murphy, R., Dave Lechner).

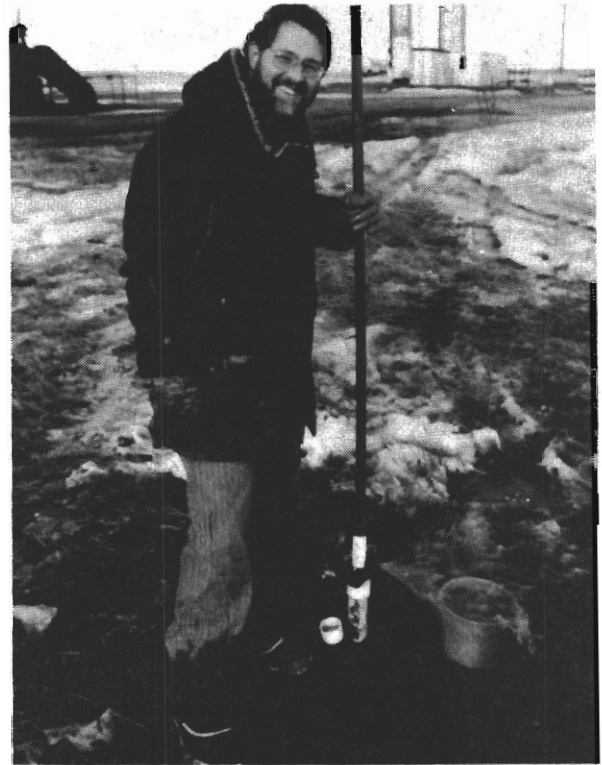

Figure 6. David O. Lechner obtaining groundwater samples from a Winderl piezometer.

core barrel, attached to a rotary rig, was used to sample the till samples.

Hydraulic conductivity values of the screened intervals were estimated with single-well response, or slug, tests. A slug was dropped down each piezometer, which raised the water level; the head values were recorded at certain time intervals as the water level returned to equilibrium. The unrecovered head differences were plotted against time, and the hydraulic conductivity values were estimated using a method outlined by Hvorslev (1951). Single-well response tests did not work for piezometers screened within sand and gravel because head recovery was too rapid. The hydraulic conductivity values for these sediments were estimated with a textural analysis technique.

In recent studies, electrical earth resistivity methods have been used successfully to trace contaminant movement in the subsurface (Cartwright

and McComas, 1968; Reed and others, 1981; Murphy and Kehew, 1984). These methods are based on the theory that the resistivity of a geologic unit is a function of the conductivity of the porewater as well as the lithology and degree of saturation of the material. Therefore, a resistivity survey accompanied by limited chemical, hydrologic, and lithologic data can be an effective means of tracing highly conductive, contaminated groundwater.

Resistivity surveys were conducted around both study sites using a direct-current meter (Soiltest Inc. R50 Stratameter), and the Wenner electrode configuration. Figure 7 illustrates a typical Wenner array. The electrode current travels through the subsurface between the two current electrodes (C). Changes in resistivity are calculated from the voltage difference between the potential electrodes (P), and the magnitude of the induced

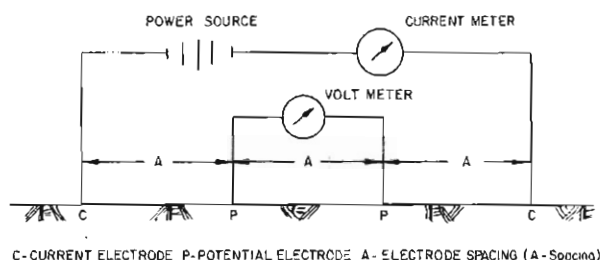

Figure 7. Configuration of the four electrode array used in the electrical earth resistivity surveys.

current. For the Wenner configuration, the electrode spacing is constant across the array, and the equation is reduced to the following:

$$\rho_a = \frac{2\pi A V}{I}$$

where (ρ_a) is the apparent resistivity, which is equal to the true resistivity only for a homogeneous, isotropic medium; (A) is the electrode spacing; (V) is the voltage difference between the two potential electrodes; and (I) is the current.

Apparent resistivity, as a function of electrode spacing, was obtained with vertical electrode sounding (VES) profiles. VES profiles are conducted by expanding the array in increments about a fixed center--the resistivity station. Apparent resistivity is determined for each successive A-spacing. Electrode spacings of 3, 5, 8, 10, 12, 16, 20, 24, 30, 40, 50, 60, 80, and 100 feet (0.9, 1.5, 2.4, 3.1, 3.7, 4.9, 6.1, 7.3, 9.1, 12.2, 15.2, 18.3, 24.4, and 30.5 m) were used in this study.

Laboratory Methods

A major objective of this investigation was to evaluate chemical and lithologic properties of the sediments. To satisfy this objective, the Shelby-tube samples were analyzed with several laboratory techniques--

specifically, textural analysis, X-ray diffraction, and saturated-paste extracts.

The textural analysis consisted of determining sand, silt, and clay percentages of selected samples. A combination of sieve and hydrometer techniques was used.

Adsorption and ion exchange is an important attenuation mechanism in groundwater flow systems. This process is particularly important for clay-size particles because of the large charge to surface-area ratio (Freeze and Cherry, 1979, p. 127). A majority of clay-size particles consist of one of several clay minerals--crystalline, hydrous silicates with layer-lattice type structure (Drever, 1982, p. 65). The attenuation properties are dependent upon the structure and thus the type of clay (Griffin and others, 1976). Therefore, X-ray diffraction was employed in this study to determine clay mineralogy. This technique is primarily qualitative, although it does give an indication of the relative abundance of the different clay minerals. Sample preparation consisted of mixing the sediment in distilled water and allowing the greater than 2-micron fraction to settle out. A sample of the remaining clay-water solution was placed on a glass disk and dried overnight. Analysis was done with a Phillips X-ray diffractometer for both air-dried and glycolated samples.

Some of these Shelby-tube sediment samples were also analyzed for major-ion content by the North Dakota State University Land Reclamation Research Center in Mandan, North Dakota. The sample preparation technique is described in detail in Sandoval and Power (1977).

As previously mentioned, single-well response tests could not be used to estimate hydraulic conductivity values for the sand and gravel deposits. Therefore, it was necessary to utilize the following relationship between

hydraulic conductivity and grain-size distribution presented by Freeze and Cherry (1979, p. 350):

$$K = A d_{10}^2$$

where (K) is the hydraulic conductivity in cm/s; A is equal to 1.0; and d_{10} is the effective grain size in mm. The effective grain size is the grain-size diameter at which 10 percent of the sediment is finer. It is obtained from the grain-size distribution curve generated from sieve analysis. This technique provides a rough estimate of hydraulic conductivity for sediments in the fine sand- to gravel-size range.

GEOLOGY OF NORTH-CENTRAL NORTH DAKOTA

Approximately 8,000 feet (2,400 m) of sedimentary rocks overlie Precambrian metamorphic rocks in western Bottineau and southeastern Renville Counties. Overlying the sedimentary deposits are between 100 and 300 feet (30 and 90 m) of glacial drift (Bluemle, 1971). Surface and near-surface stratigraphy consists primarily of Pleistocene glacial sediment of Late Wisconsinan age--either deposited directly by the glacier during the last advance, or by water associated with the glacier.

The bedrock-surface lithology varies as successively younger units subcrop below the glacial cover toward the center of the Williston Basin. Near Maxbass (fig. 3), the underlying bedrock includes massive to interbedded sandstones, siltstones, claystones, and shales of the Cretaceous Fox Hills Formation. Overlying the Fox Hills is a lithologically similar sedimentary unit, the Cretaceous Hell Creek Formation, which comprises the bedrock surface for most of the area between Maxbass and Glenburn. Closer to the center of the basin, the subglacial bedrock is a

marine silty sandstone, the Cannonball Formation (Tertiary). The subcrop contact between the Hell Creek and the Cannonball trends northwest-southeast through the Glenburn area (Bluemle, 1983).

The glacial drift consists primarily of till interbedded with discontinuous sand lenses and buried glaciofluvial-channel sediments. These deposits are the result of several glacial advances during the Pleistocene Epoch (Bluemle, 1985). The surficial landscape was shaped by the last Wisconsinan glacier, which receded from the area about 12,000 years ago. In western Bottineau and eastern Renville Counties, the glacier receded to the northwest, and meltwater from the diminishing glacier formed Lake Souris. At its maximum extent, this glacial lake covered 6,000 km² of north-central North Dakota, including much of Bottineau County (Kehew and Clayton, 1980). Meltwater flowing from the glacier toward Lake Souris incised the till plain with numerous glaciofluvial channels. Many of these channels have since been incorporated into the present-day drainage system.

The surficial geology of the study area is divided into the following three units: till, fluvial and glaciofluvial sediments, and lacustrine deposits (fig. 8).

Till exposed at the surface generally forms gently undulating topography interpreted to indicate collapse of supraglacial sediment associated with melting of the underlying ice (Clayton and others, 1980b). Some areas also show evidence of post-glacial erosion by fluvial and lacustrine processes (Moran and others, 1985). The till contains varying amounts of clay, silt, and sand, as well as some pebbles, cobbles, and boulders. These sediments were ultimately derived from the bedrock underlying the glacier--specifically, igneous, metamorphic, and carbonate rocks in Canada, and local bedrock

GROUNDWATER RESOURCES OF NORTH-CENTRAL NORTH DAKOTA

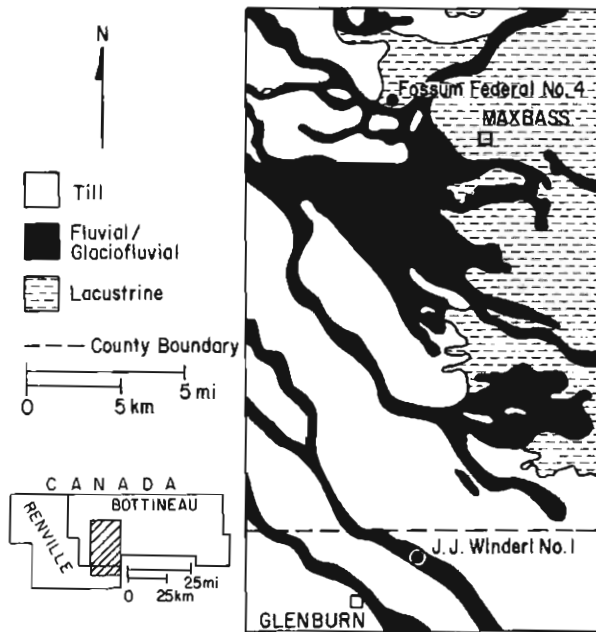

Figure 8. Geologic map of the study areas (modified from Moran and others, 1985).

formations (Bluemle, 1985).

The glaciofluvial and fluvial sediments were deposited in channels incised into the till surface. These sediments typically are between 10 and 20 feet (3 and 6 m) thick. However, in the Glacial Lake Souris area, the channels fan out in a "deltaic" pattern and are less than 10 feet (3 m) thick and they cover a wide area (Bluemle, 1985). Sediments associated with the channels are generally subangular to subrounded, moderately well-sorted sands and poorly sorted gravels. Mineralogically, they are similar to the surrounding till (Bluemle, 1985).

The lacustrine deposits were deposited in Glacial Lake Souris. In most surface exposures they are represented by nearshore bedded silts grading to fine sands draped over the till plain. However, in the northwest corner of the study area, a small percentage of the surficial sediments are offshore silts and clays (Moran and others, 1985).

Groundwater for stock and domestic purposes is derived from both glaciofluvial and bedrock aquifers in the area. According to county groundwater studies (Pettyjohn and Hutchinson, 1977; Randich and Kuzniar, 1984), the Fox Hills and Hell Creek Formations are the primary bedrock aquifers. These studies further indicate that water obtained from the bedrock typically has sodium as the dominant cation and chloride or sulfate as the dominant anion. The total dissolved solids are generally greater than 2,000 mg/l, making the water undesirable for most domestic purposes. Nevertheless, some areas lack any other water source, and these bedrock aquifers are utilized.

Glaciofluvial deposits, either buried or exposed at the surface, are the primary source of groundwater in the area. These deposits yield large amounts of high-quality water that is suited for both domestic and stock purposes. The dominant cation typically is calcium or sodium, and the dominant anion is bicarbonate or sulfate; total dissolved solids are on the average less than 1,700 mg/l (Pettyjohn and Hutchinson, 1977; Randich and Kuzniar, 1984).

J. J. WINDERL #1

Introduction

A reconnaissance study was conducted to locate a suitable buried disposal pit in sand and gravel. The J. J. Windertl #1 well in the Glenburn Field was selected by examining the geologic map of North Dakota (Clayton and others, 1980a) for surface exposures of sand in areas close to the Fossam site, which had already been selected (fig. 9). The Windertl well was drilled in 1959 by the

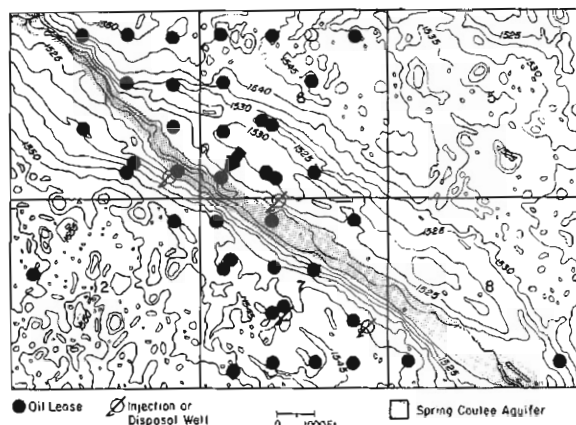

Figure 9. Topographic map of a portion of the Glenburn Field in Renville County.

California Company to a depth of 4,478 feet (1,365 m) and treated with 500 gallons (1,900 L) of acid. It produces oil from the Mission Canyon Formation. The reserve pit was not lined and probably was reclaimed by pushing sediment into the pit from the sides.

In 1980, the Winderl well was deepened to 4,597 feet (1,402 m) and acidified again with 2,300 gallons (8,700 L) of HCl. A second pit was excavated. It is not known whether this pit was lined; however, the trenching method probably was used for reclamation.

Information was unavailable for either the 1959 or the 1980 drilling mud chemistry at this site. However, using the mud resistivity and temperature from the electric log heading of this hole, the NaCl content was estimated to be between 16,000 and 40,000 ppm (Schlumberger, 1978). The drilling fluid is generally not salt saturated (i.e., 250,000-300,000 mg/l) in this area because there are no major salt sections above the Glenburn producing horizon (LeFever and Anderson, 1986). The 1980 re-entry was not logged and, therefore, the salt content of the mud cannot be estimated from the log heading. They did not encounter any salt beds in the deepened hole (Anderson, 1987).

After freeze-up, operators commonly use field brines as make-up waters because surface water is unavailable (Borchert, 1987). The produced brines from the Glenburn Field have a wide range of ion concentrations but generally contain high concentrations of the major ions (table 2).

Local Geology and Geohydrology

The ground surface at the Winderl site slopes gently to the south toward a low-lying marshy area adjacent to Spring Coulee Creek (figs. 10, 11). A majority of the piezometers were installed to the south of the buried disposal pit, under the assumption that the equipotential lines mirror the topography and that groundwater flow was in the downslope direction. Approximately 700 feet (213 m) to the north, three piezometers (1p, 2p, and 3p) were installed to obtain background information (fig. 12).

Figure 13 is a geologic fence diagram that illustrates the three-dimensional stratigraphy at the Winderl site. Till, interbedded with discontinuous sand lenses, is overlain by sand and gravel from a glacial meltwater channel. The meltwater channel generally is between 14 and 16 feet (4.3 and 4.9 m) thick, increasing to 33 feet (10.1 m) to the northwest. A surface organic layer, up to 2 feet (0.61 m) thick, overlies the meltwater-channel sediments in the low-lying marshy area. Both of the drilling fluid disposal pits are located within the sand and gravel unit and are capped by fill material. Nested piezometers were generally installed at three different stratigraphic horizons, one in the upper sand and gravel and the other two at different depths within the underlying till. Two pressure-vacuum lysimeters were installed within the buried disposal pit.

The upper sand and gravel unit acts as an unconfined system, which

Table 2. High, low, mean of brines in the Glenburn Field (mg/l).
Taken from 69 samples.

| | <u>TDS</u> | <u>CA</u> | <u>MG</u> | <u>NA</u> | <u>CL</u> | <u>SO₄</u> |
|-----------|------------|-----------|-----------|-----------|-----------|-----------------------|
| H | 335,542 | 31,360 | 4,720 | 121,674 | 204,260 | 4,000 |
| L | 4,148 | 539 | 168 | 4,584 | 899 | 112 |
| \bar{x} | 233,439 | 6,436 | 1,469 | 82,012 | 141,354 | 1,601 |

has been named the Spring Coulee Creek Aquifer (Pettyjohn and Hutchinson, 1977). Textural analyses were performed on two meltwater-sediment samples from the Winderl site. The following gravel, sand, silt, and clay percentages were calculated from these analyses:

| | <u>Gravel</u> % | <u>Sand</u> % | <u>Silt</u> % | <u>Clay</u> % |
|-----------------------------|--------------------|------------------|------------------|------------------|
| 25p (3 ft-6 ft) (0.9-1.8 m) | 3.2 | 84.2 | 9.2 | 3.4 |
| 1s (5 ft-8 ft) (1.5-2.4 m) | 16.9 | 77.6 | 5.5 | 0.0 |

The sand-size grains are predominantly quartz and granitic rock fragments. The gravels mainly consist of carbonates, shales, and granitic rock fragments.

The water table was determined from the piezometers screened within these sediments. During the monitoring period (October 1984 to November 1986), the depth to the water table varied from less than 2 feet (0.61 m) below the surface in the low-lying marshy area to more than 6 feet (1.8 m) below the surface to the north and east (3p and 29p). Water table maps (fig. 14) indicate that groundwater within this unconfined aquifer generally is flowing to the south-southeast or south-southwest, away from the disposal pits. An exception to this trend was observed in January of 1985 when there were northeasterly components of flow away from the disposal area.

The hydraulic conductivity of the till at the Winderl site was estimated from 12 single-well response tests (slug

tests). These tests yielded values that range from 2.4×10^{-6} cm/s to 5.6×10^{-3} cm/s, averaging 5.6×10^{-4} cm/s.

Grain-size distribution curves were generated from sieve analyses of two samples taken from the upper sand and gravel unit at the Winderl site. The effective grain sizes (d_{10}) from these curves were used to estimate hydraulic conductivities. Values of 1.7×10^{-2} cm/s and 1.5×10^{-1} cm/s were obtained from samples 25p and 1s, respectively. These magnitudes are considered to be within the clean sand- to gravel-size range (Freeze and Cherry, 1979, p. 29).

Drilling mud was found buried at a depth of 5-15 feet (1.5-4.6 m) below the surface in the 1959 pit. The water table fluctuated between 4-6 feet (1.2-1.8 m) below the surface during the monitoring period. Therefore, most or all of the 1959 drilling mud was below the water table. We did not drill into the 1980 mud pit because of its proximity to a buried salt-water line. It is reasonable to assume that most of the 1980 drilling mud is also buried below the water table.

Apparent Resistivity

Thirty resistivity stations were surveyed at the Winderl site. Apparent resistivity values were calculated and iso-resistivity maps were constructed for each electrode spacing (fig. 15). Apparent resistivity is equal to the true resistivity only in a homogeneous, isotropic medium. With the Wenner

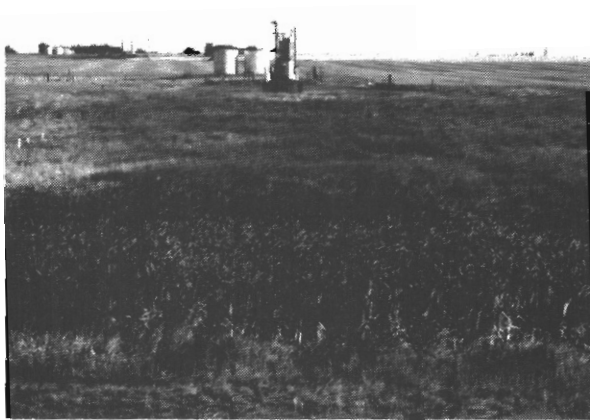

Figure 10. The J. J. Winderl #1 study site, Renville County. Photo taken looking due north.

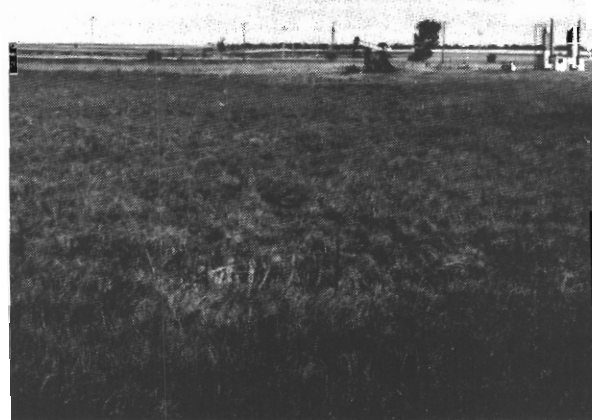

Figure 11. The J. J. Winderl #1 study site, Renville County. Photo taken looking west-northwest.

electrode configuration, a rule of thumb states that the apparent resistivity is a weighted average over a hemispherical bowl of a radius equal to the electrode spacing (Greenhouse and Harris, 1983). This rule holds true only if the A-spacing is approximately equal to the depth of current penetration. Electrode spacings of 5-16 feet (1.5-4.9 m) give an indication of groundwater conditions within the sand and gravel unit, assuming that the depth of current penetration equals the electrode spacing. Resistivities directly to the northwest and to the south of the disposal pit are less than 30 ohm-feet (10 ohm-m). There is also an area of less than 20 ohm-feet (6.1 ohm-m) in the southwest corner of the study area. Typical resistivity values for sand and gravel deposits range from 1,000 to 10,000 ohm-feet (300 to 3,000 ohm-m) (Soiltest, 1968). There was one station in the northeast corner of the study area that indicated apparent resistivity values within this normal range. The resistivity distribution suggests that the groundwater upgradient and downgradient from the pits is very high in TDS and/or chloride. The apparent iso-resistivity map for the 20- to 100-foot (6.1- to

30.5-m) electrode spacings should represent conditions deeper within the strata (fig. 15). The high conductivity of the near-surface sediments will impede current penetration, making it difficult to evaluate the vertical resistivity distribution. These maps demonstrate the same general pattern as seen on the shallower maps. The resistivity values generally range from 20-60 ohm-feet (6.1-18.3 ohm-m) throughout the study area.

Groundwater Chemistry

Isoconcentration maps have been constructed for various parameters from the groundwater chemistry samples from piezometers screened in the meltwater channel sediments (0-16 feet [0-4.9 m]) (fig. 16). In general, the highest concentrations of ions were detected in piezometers 4 through 7p and 30 through 32p, which are located directly south of the 1981 re-entry reserve pit (5,000-24,000 mg/l of TDS and 2,500-10,000 mg/l of Cl) (figs. 12, 16). The major ion concentrations in the groundwater are generally 2 to 4 times greater adjacent to the 1981 re-entry mud pit as compared to the 1959 pit (table 3).

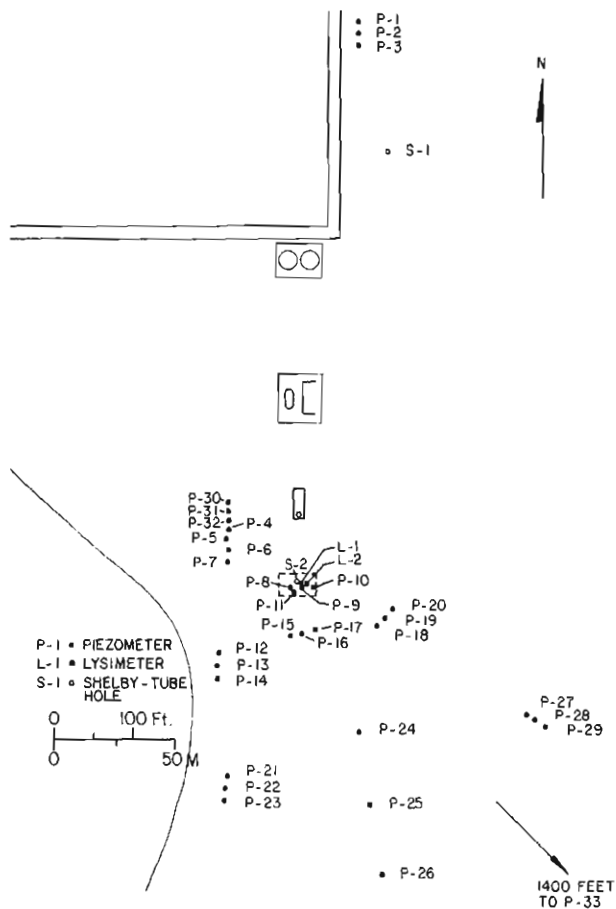

Figure 12. Map view of the Winderl site depicting the location of water sampling instrumentation and Shelby-tube holes. The reserve pit boundaries are approximated by a dashed line near the center of the diagram.

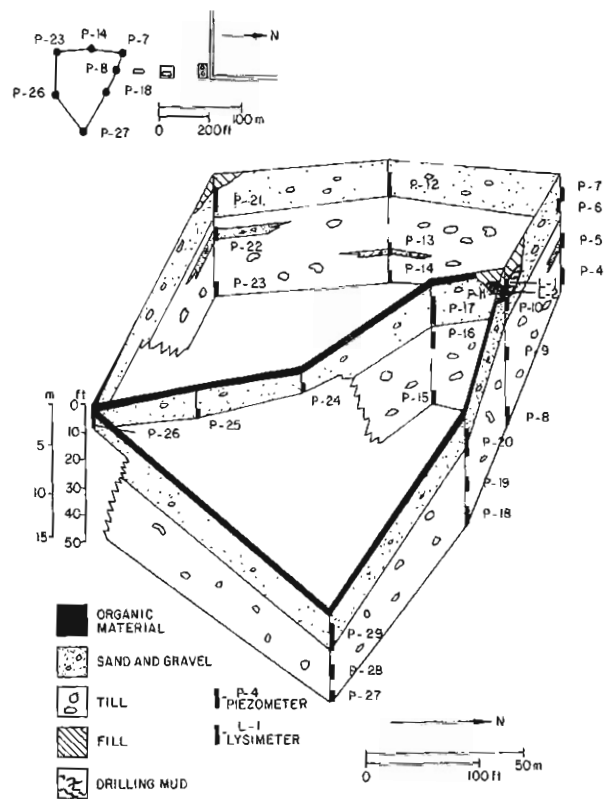

Figure 13. Geologic fence diagram of the Winderl site.

There is no indication of the initial resistivity of the 1981 drilling fluid; therefore, the difference in the initial salt content of the two pits cannot be estimated. The difference in concentrations between the two pits may be a result of the higher salt content of the 1981 mud, the leaching of the 1959 drilling mud over a 26-year period, or a combination of both.

Another contaminant plume appears to be centered around piezometer 25p. This piezometer is located 300 feet (91.4 m) southeast of the original reserve pit and contains concentrations

of 6,000-10,000 mg/l of TDS and 3,500-5,000 mg/l of Cl.

The isoconcentration maps from 1984 and 1985 are very similar to each other for a given parameter in both their general pattern and concentrations (fig. 16). The 1986 isoconcentration map, however, is somewhat different. The same general pattern is present, but there is an overall decrease in the 1986 concentrations from the previous values (fig. 16).

The decline in leachate levels found in the groundwater at the Winderl site

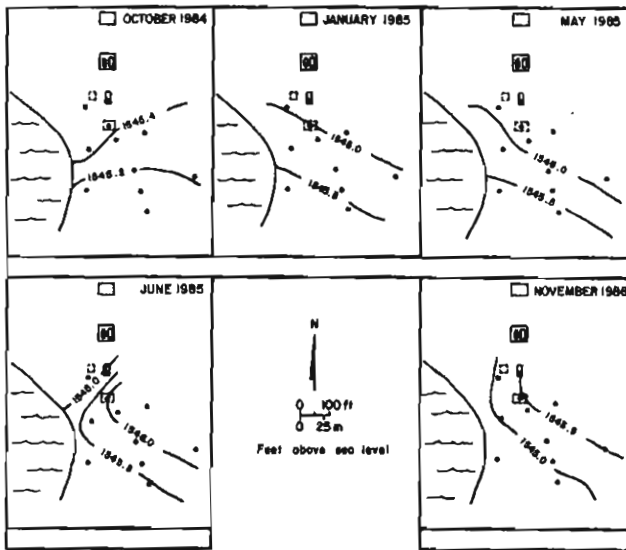

Figure 14. Water table maps of the Winderl site (October, 1984 to November, 1986).

in 1986 most likely reflects the variability in recharge during the sampling period. The monthly precipitation obtained from a recording station near the study site shows that an abnormally high amount of precipitation fell during October of 1984 (groundwater samples were obtained on the 26th of that month) (fig. 17). The corresponding low levels of evapotranspiration that normally occur at this time of the year would have resulted in high amounts of groundwater recharge (Rehm et al., 1982). This would have created a corresponding increase in the amount and concentration of drilling fluid leachate. The same can be said for the water samples which were obtained on June 13, 1985. The major groundwater recharge event in this area usually occurs in the spring (Rehm et al., 1982) and there was ample rainfall during May and June of 1985 (fig. 17). In contrast, the ground was partially frozen when we sampled on November 26, 1986, and there had been very little precipitation during the previous three months (fig. 17). The variation in ionic

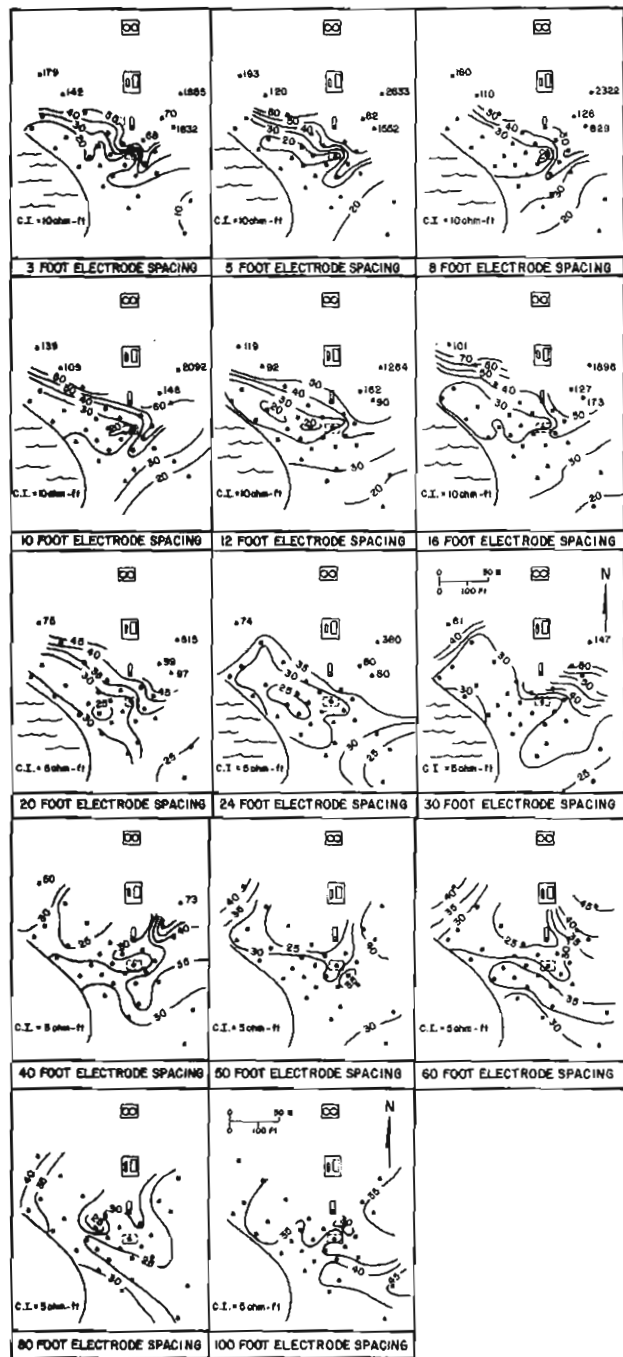

Figure 15. Apparent isoresistivity maps of the Winderl site for electrode spacings of 3, 5, 8, 10, 12, 16, 20, 24, 30, 40, 60, 80, and 100 feet (0.9, 1.5, 2.4, 3.1, 3.7, 4.9, 6.1, 7.3, 9.1, 12.2, 15.2, 18.3, 24.4, and 30.5 m).

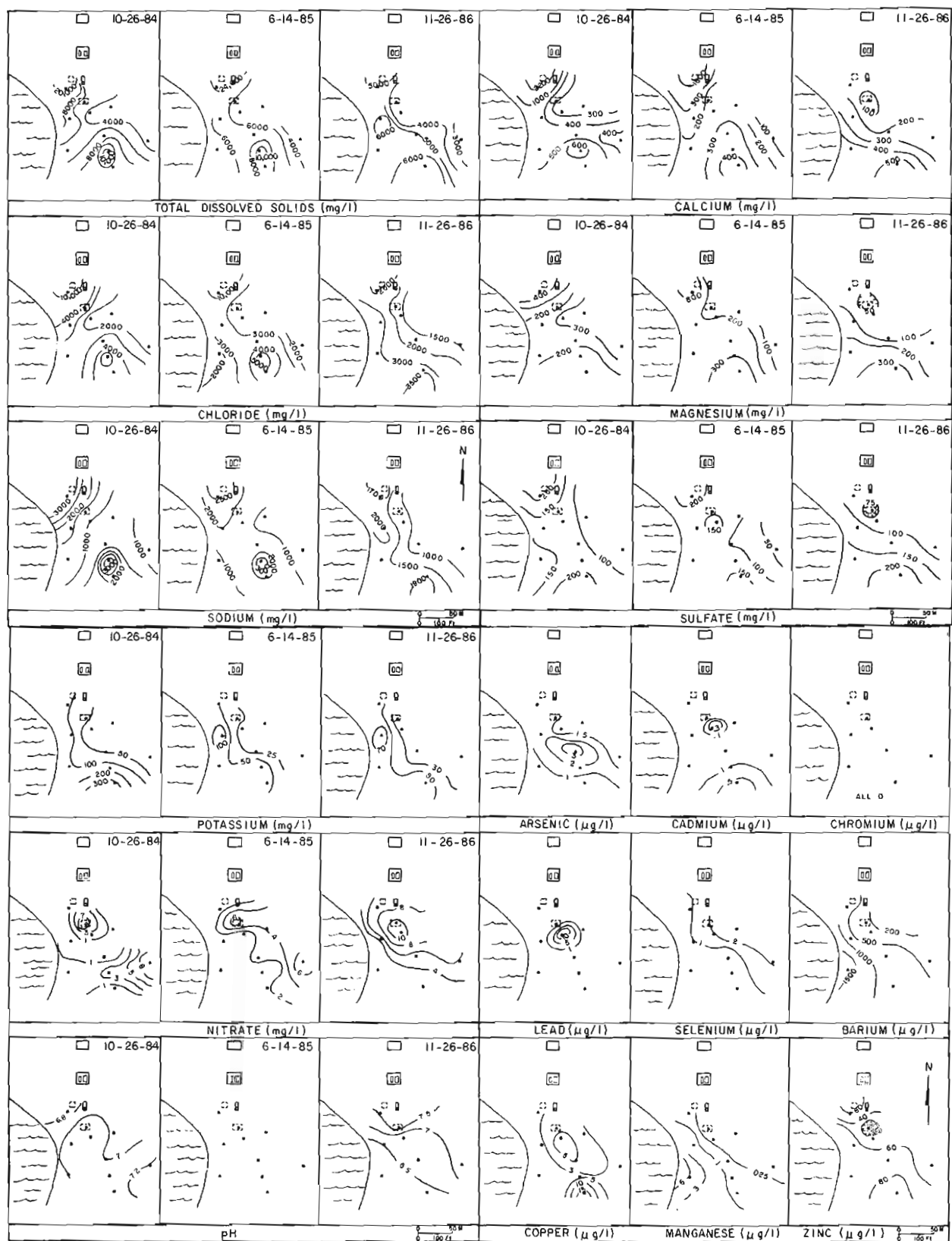

Figure 16. Isoconcentration maps for major ions and trace metals within the meltwater channel at the Windler site. Maps are constructed from groundwater samples obtained on October 25, 1984, June 14, 1985, and November 26, 1986.

Table 3. TDS, Cl, and NO₃ concentrations in groundwater adjacent to the 1959 and 1980 drilling mud and normal levels of these ions in groundwater (mg/l).

| PARAMETER | TDS | | | Cl ⁻ | | | NO ₃ ⁻ | | | |
|-------------------|-------------|-----------|--------|-----------------|--------|--------|------------------------------|-----|-----|----|
| | Sample Year | 84 | 85 | 86 | 84 | 85 | 86 | 84 | 85 | 86 |
| 1959 Pit | | 4,898 | 5,090 | 3,300 | 2,316 | 2,530 | 1,790 | 7.2 | 6 | 10 |
| 1980 Pit | | 20,335 | 24,355 | 5,095 | 10,195 | 10,700 | 2,765 | - | 0.2 | 7 |
| Background levels | | 300-1,500 | | | 10-30 | | | 0-5 | | |

concentration levels for groundwater at this site appears to reflect the variable amounts of precipitation, and therefore, recharge that occurred previous to each of the samplings.

The concentrations of trace metals in the shallow groundwater at the Winderl site in November of 1986 were generally low (fig. 16). Lead was the only trace metal that appeared to be leaching out of the 1959 drilling mud, and zinc was the only metal elevated in the areas near the 1980 buried drilling mud (Pb 10 µg/l and Zn 60 µg/l) (fig. 16). The isoconcentration maps for cadmium, copper, and zinc demonstrate an area of elevated concentrations along the southern edge of the study areas. This pattern was also evident on the major ion maps.

The oil and gas wells that are drilled in the Glenburn Field usually do not encounter much H₂S, which is an indication that little or no trace metal compounds were added as corrosion inhibitors. This was confirmed by the absence of detectable chromium in the groundwater at this site.

A comparison of the trace metal concentrations in the shallow groundwater at the Winderl site between 1984 and 1986 shows good correlation for the arsenic values, i.e., consistently low (0.8-2.5 µg/l) (table 4). However, this comparison is not as

consistent for the chromium and lead values. Lead was detected in low to moderate amounts in the 1984 samples by the North Dakota State University (NDSU) laboratory. The Health Department laboratory only found lead in detectable limits in one of these piezometers (17p) (table 4). Moderate to high concentrations (9-417 µg/l) of chromium were reported in 1984 as compared to no detectable chromium concentrations in these piezometers in 1986. The difference between the concentration levels may not be due to geochemical changes in the field, but may be due to the different methodologies used by each of the two laboratories.

The 1984 and 1985 samples were analyzed for trace metals by a chemistry laboratory at NDSU. The analyses were conducted using a graphite furnace on a Perkin-Elmer 603 atomic absorption unit. The method of standard addition was used on these metals with the exception of arsenic, which was analyzed by generating the hydride and trapping it in a KCl₃ solution prior to injection into the graphite furnace. Because of the uniformity of the matrix a standard curve was used for arsenic.

High concentrations of salts can cause interference within the graphite furnace which results in falsely high

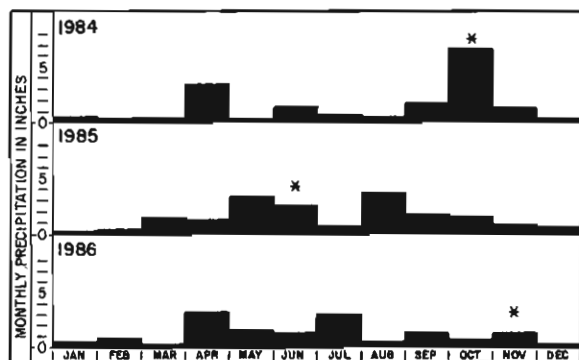

Figure 17. Monthly precipitation (in inches) for 1984-1986 at a recording station (Foxholm) near the study site. (*) denotes when quarterly sample was taken.

readings (Holliday, 1986). To minimize the effects of this interference, the North Dakota State Department of Health, Division of Chemistry Laboratory, used the following methods to analyze for trace metals:

Zinc, copper, barium, and manganese were analyzed by emission spectroscopy using a Perkin-Elmer Plasma II inductively coupled plasma emission spectrometer. This system uses two-point background correction and vacuum monochrometers.

Chromium, arsenic, and selenium were analyzed on a Perkin-Elmer 5100 atomic absorption spectrometer using stabilized temperature platform furnace technology and Zeeman background correction to control interferences from high chloride content.

Lead and cadmium were analyzed on a Perkin-Elmer Model 5000/500 atomic absorption spectrophotometer using stabilized temperature platform furnace technology.

All analyses were performed using EPA methodology. Spikes and duplicates were performed on a minimum of 10 percent of all samples. Known EPA reference samples were run with all metal analyses (Reetz, 1987). Therefore,

the Health Department laboratory may reflect the more accurate trace metal concentration levels.

Density Stratification of Contaminant

Beal (1986) constructed chemical profiles from the eight piezometer nests. Two of these nests contain piezometers screened at different intervals within the sand and gravel unit (piezometers {6p and 7p} and {10p and 11p}). Piezometer 6p was screened from 9.5-14.5 feet (2.9-4.4 m) and was found to contain concentrations of ions generally twice those of groundwater in piezometer 7p (screened interval is 4.5-9.5 feet (1.4-2.9 m) (fig. 18). Beal (1986) proposed that the drilling fluid leachate is denser than the surrounding groundwater. The greater density caused the plume to migrate horizontally along the base of the meltwater channel at the gravel/till contact.

To test this interpretation, three additional piezometers were installed adjacent to piezometers (6p and 7p). Each of the piezometers has a 2-foot (0.61 m) screen and, collectively, they were screened at depths of 16, 13, and 10 feet (4.9, 4.0, and 3.05 m) (fig. 19). The November 1986 groundwater analyses from these piezometers document that the ion concentrations in groundwater at the base of the gravel unit is 2-4 times higher than concentrations that were detected in the piezometers screened higher in the unit (fig. 19).

Sulfate is the only ion that was found to deviate from this pattern (fig. 18, 19). This may be the result of sulfate reduction in deeper levels of the aquifer where reducing conditions exist.

Contaminant Migration

The isoconcentration maps for both major ions and trace metals at the

Table 4. Trace metal concentrations (in $\mu\text{g/l}$) of chromium, lead, and arsenic in shallow groundwater at the Winderl site.

| PARAMETER | CHROMIUM | | LEAD | | ARSENIC | |
|-----------|----------|-----|------|-----|---------|-----|
| | 84 | 86 | 84 | 86 | 85 | 86 |
| 6p | 417 | 0.0 | 25 | 0.0 | 1 | 1.8 |
| 10p | 22.6 | 0.0 | 6.3 | 0.0 | 1.1 | 1.7 |
| 12p | 36.2 | 0.0 | 7.6 | 0.0 | 1 | 1.8 |
| 17p | 15 | 0.0 | 8.8 | 9.7 | 1 | 1.3 |
| 20p | 9 | - | 1.4 | - | - | - |
| 21p | 16.7 | 0.0 | 4.9 | 0.0 | 1.1 | 0.9 |
| 24p | - | 0.0 | - | 0.0 | 2.0 | 3.2 |
| 25p | 52 | - | 15.7 | - | 1 | - |
| 26p | - | 0.0 | - | 0.0 | 2.5 | 0.8 |
| 29p | 26.9 | 0.0 | 2.9 | 0.0 | 1.8 | 1.3 |

Winderl site demonstrate that leachate has migrated beyond the 400- to 500-foot (122-152.4 m) study boundary (fig. 16). In November of 1986, another piezometer was installed in the meltwater channel approximately 1,800 feet south of the Winderl pits (fig. 20). The piezometer (33p) is 12 feet (3.7 m) deep and has a 2-foot (0.61 m) screen. The groundwater from this piezometer contained concentrations of major ions (TDS = 5,200 mg/l) and arsenic (31 $\mu\text{g/l}$) elevated above the normal background levels (fig. 20). This piezometer is located approximately 300 feet (91.4 m) north of a site containing an abandoned well and brine pit, 600 feet (182.9 m) southwest of an active saltwater disposal well (fig. 20). The contaminants that were detected in the groundwater at this site could be migrating from any one of these potential sources. The transport of non-reactive solutes in groundwater commonly is described by two processes: advection, or transport due to the bulk movement of the groundwater, and dispersion, which is the spreading out of the contaminant as it flows through the subsurface (Anderson, 1984). Advection will cause

the contaminant to travel away from the source in the direction of groundwater flow. Dispersion results in dilution of the contaminant downgradient as it spreads out over a larger area.

The one-dimensional advection-dispersion equation for non-reactive dissolved constituents in a saturated-homogeneous medium under steady-state conditions can be written as follows:

$$D \frac{\partial^2 C}{\partial l^2} - v \frac{\partial C}{\partial l} = \frac{\partial C}{\partial t}$$

where t is time, l is the groundwater flow direction, C is the concentration of solute, v is the average linear velocity, and D is the coefficient of hydrodynamic dispersion. The hydrodynamic dispersion coefficient has two components, dispersivity and diffusion. Except for very fine-grained sediments, diffusion is considered negligible.

This one-dimensional equation is utilized to evaluate solute transport in the Spring Coulee Creek Aquifer at the Winderl site. With a hydraulic

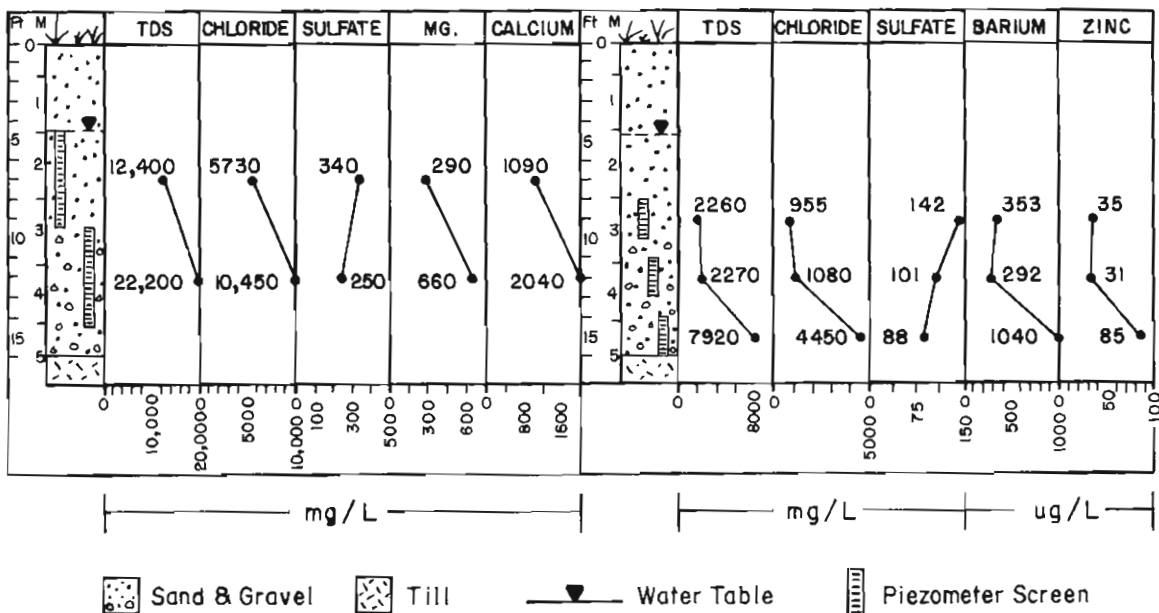

Figure 18. Total dissolved solids, chloride, sulfate, magnesium, and calcium concentration profiles for piezometers 6 and 7. The concentrations are the mean of the October, 1984 and June, 1985 samples.

Figure 19. Total dissolved solids, chloride, sulfate, barium, and zinc concentration profiles for piezometers 30, 31, and 32. Concentrations are from the November, 1986 analysis.

conductivity (K) of 8.4×10^{-2} cm/s (the average value from the grain-size distribution curves in Beal, 1986), a porosity (n) of 0.25, and a gradient (i) of 0.001 (obtained from the October 1984 water table map), the average linear velocity (v) is calculated from the following equation:

$$v = \frac{K i}{n}$$

yielding a value of 0.29 m/day (0.95 ft/day).

The dispersivity parameter controls the degree of spreading and dilution of a solute plume. Dispersivity is related to the heterogeneity of a unit and also the scale of observation. Accordingly, to quantify dispersivity accurately, field tracer tests should be conducted, which are beyond the scope of this study. Gelhar and others (1985) present results of several investigations with field

tracer tests to estimate dispersivity in glaciofluvial sediments. These results were utilized to select three different dispersivity values (1m, 25m, and 100m) that are thought to create a range that includes the dispersivity of the Spring Coulee Creek Aquifer at the scale of this investigation.

A computer program, ODAST (Javandel and others, 1984), was utilized to solve this one-dimensional equation. It was assumed that a point source had been active from 1960 to 1984. Breakthrough curves that depict the theoretical distribution of the contaminant with distance are presented in figure 21. These curves illustrate the potential for widespread contamination within the Spring Coulee Creek Aquifer. The analytical solution predicts concentrations of non-reactive constituents that approach the concentration at the source at distances up to 3,280 and 7,218 feet

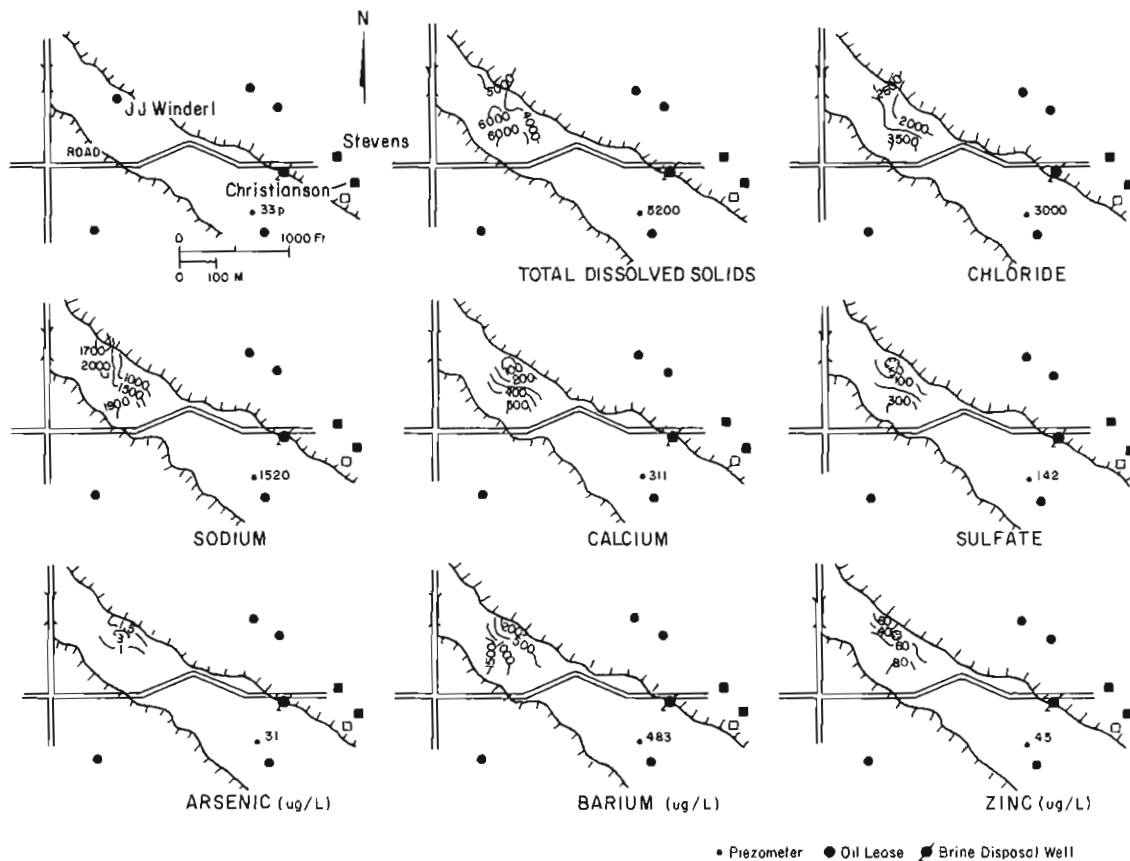

Figure 20. Location map of the Winderl site and the Spring Coulee Creek meltwater channel and isoconcentration maps of TDS, Cl, Na, Ca, SO_4 , As, Ba, and Zn within the Spring Coulee Creek Aquifer. All concentrations are in mg/l unless otherwise noted.

(1,000 to 2,200 m) downgradient from the buried disposal pit, for dispersivities of 1 metre and 100 metres, respectively.

Several problems are inherent with the one-dimensional analytical solution approach. A homogeneous isotropic medium with steady-state flow is never duplicated in actual situations. Also, the disposal pit at the Winderl site probably does not act as a continuous point source, but rather has diminished in concentration with time. Concentrations in the vicinity of the disposal pit are less than other areas at the study site,

which indicates the source of contamination has been diluted.

Normal background levels of ions were not found in groundwater from any of the 33 piezometers that were installed at the Winderl site. The northernmost piezometer nest (1-3p) was positioned upgradient of the buried drilling mud to enable a comparison of the background chemistry to that of the drilling fluid leachate. However, the chloride concentrations (401 and 146 mg/l) in piezometer 3p are well above the 10-30 mg/l levels normally found for

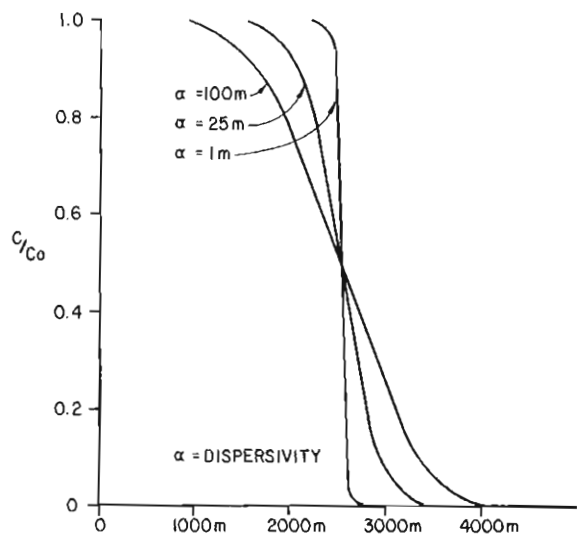

Figure 21. Hypothetical breakthrough curves at the Winderl site for the transport of non-reactive solutes at dispersivities of 1 m, 25 m, and 100 m. C/C_0 is the ratio of the concentration at any point in the flow system (C) to the original concentration at the source (C_0).

chloride in unaffected shallow aquifers in this area (Pettyjohn and Hutchinson, 1971). These elevated concentrations may be coming from one of three leases located to the north, northwest, and west of the Winderl well (fig. 9). Another potential source would be a leak from one of the many buried salt-water pipe lines that criss-cross this area. Three shallow farm wells are screened within the Spring Coulee Creek Aquifer 1/3 mile south (down-gradient) of the Winderl lease. The concentrations in these wells indicate contaminant (table 5); whether this contaminant is from oil field related activities or from farm activities has not been determined. The high nitrates in the Stevens farm well is probably coming from barnyard wastes (table 5).

Contaminant in Till

As previously discussed, the piezometers were generally installed in

nests of three. The two deeper piezometers were screened in the till at depths of approximately 30 and 40 feet (9.1 and 12.2 m) below the surface. Additional piezometers were screened at various depths in the sand and gravel unit (fig. 22). A comparison of the chloride profiles (concentration vs. depth) for the eight piezometer nests shows that the highest concentrations of chloride were detected in the piezometers screened in the upper portion of the till for six of the eight nests (fig. 23). Beal (1986) found this scenario was also true for the other major ions. Although it has been demonstrated that groundwater velocity through these tills can be high, the flux of water, thus the mass of contaminants, is low. Also, these contaminants are attenuated by matrix diffusion as they migrate along fractures. There is little potential for downward migration through the sand and gravel because the flow through this unit is predominantly horizontal. It is therefore unlikely that the highest concentrations of contaminants are in the till. This appears to be the result of the density stratified leachate plume and cross-contamination between the two sedimentological units due to well construction techniques.

The annular space above the well screens, for the wells screened in till, was filled with approximately 2 feet (0.61 m) of cement and then backfilled to the surface with cuttings. The backfill material consisted primarily of sand and gravel. The dense contaminants were probably able to migrate down the annulus and accumulate above the cement layer. A seal from the cement layer is unlikely due to the low volume of cement in the hole, and the fact that the cement was poured from the surface through an annulus filled with saltwater. Purging of the wells before sampling could have allowed for downward migration of contaminants through the

Table 5. Comparison of TDS, Cl, Na, SO₄, and NO₃ in three farm wells downgradient from the Winderl site. Samples obtained during 1984 and 1985. Analysis provided by North Dakota State Department of Health Laboratory (mg/l).

| | DEPTH | TDS | | Cl ⁻ | | Na | | SO ₄ | | NO ₃ | |
|------------------------------|-------|-------|-------|-----------------|-------|-----|-------|-----------------|----|-----------------|----|
| | | 84 | 85 | 84 | 85 | 84 | 85 | 84 | 85 | 84 | 85 |
| March Stevens (house) | 14' | 749 | 542 | 95 | 82 | 119 | 55 | 51 | 39 | 35 | 20 |
| March Stevens (livestock) | 14' | - | 2,860 | - | 1,440 | - | 1,030 | - | 0 | - | 0 |
| Paul Christianson | 14' | 3,433 | 679 | 971 | 43 | 169 | 31 | 67 | 78 | 1.4 | 42 |

cement layer and to the well screen.

The highest concentrations were detected in wells screened in till because samples from the wells screened in the overlying sand and gravel unit are diluted by the "less-contaminated water" collected from above the sand and gravel-till contact. Groundwater in the cross-contaminated till wells, on the other hand, is from the annular space above the cement plug where the dense contaminants had accumulated.

Piezometer nests (4-7p and 18-20p) have the concentration profile which is to be expected for this type of setting. The highest concentration of chloride in these nests is found in the sand and gravel unit (fig. 23). This appears to be the result of a good seal above the screens in the till piezometers in these two nests.

The deep till wells (40-50 feet {12.2-15.2 m}) have much lower ion concentration levels than the shallow till piezometers. Cross-contamination does not appear to be as significant a problem for these deeper piezometers because the increased volume of till cuttings provided a thicker mud system. This viscous mud held the holes open

longer, thus allowing time for the cement to get down the hole. However, even the ion concentrations in these holes are elevated above those normally expected. Due to the probability of cross-contamination of all or most of the till piezometers, the resulting chemical data was not used to interpret the actual concentrations in the till.

Interpreted Resistivity

The interpreted resistivity values are utilized to evaluate the distribution of the contaminants at the Winderl site. Two cross sections illustrating Dar-Zarrouk interpreted values of resistivity with depth are presented in figure 24. For comparison, the isoconcentration map of total dissolved solids is also shown. A layer of high resistivity is indicated in the northeastern part of the study area near station 1 (fig. 24). These high resistivity values probably reflect the thickening of the sand and gravel unit to the north, and also the higher surface elevation (i.e., thicker unsaturated zone). These lithologic variations tend to mask any variations

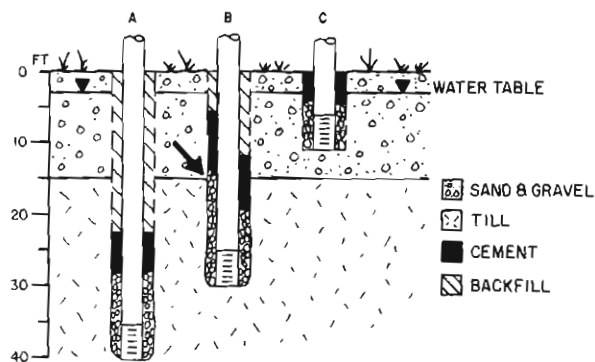

Figure 22. Profiles of piezometer installation at the Winderl site. An improper seal on piezometer B explains why high levels of contaminants were detected in the till underlying the Spring Coulee Creek Aquifer.

in resistivity due to groundwater contamination. Figure 24 indicates relatively high resistivity values (100 to 1,000 ohm-ft {30.5 to 304.8 ohm-m}) in the northeastern part of the study area near stations 6 and 7. There are no wells or borings in this area, so it is not evident whether these resistivity values are a reflection of lithology or groundwater conductivity.

South of the buried disposal pit, the thickness of the sand and gravel unit is relatively uniform and resistivity is thought to be a good contaminant indicator. The cross sections in figure 24 illustrate that the southern area is interpreted to be underlain primarily by a low-resistivity layer (50 ohm-ft {15.2 ohm-m}). An isolated area of higher resistivity (50 to 100 ohm-ft {15.2 to 30.5 ohm-m}) is interpreted approximately 5 feet (1.5 m) below the surface, southeast of the disposal pit, near stations 12 and 13. The TDS plume map (fig. 24) shows a decrease in the concentration of contaminants within this area. It is not clear, however, whether the lower TDS values are the cause of the higher resistivity. Regardless, the interpreted resistivity values to the south of the disposal pit are significantly below the 1,000 to

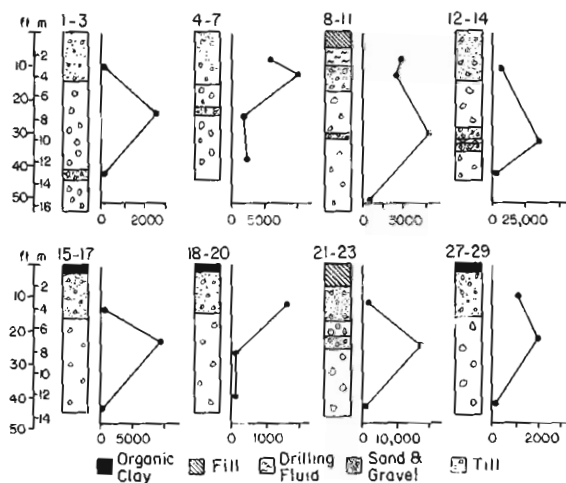

Figure 23. Lithologic column and chloride concentration profiles for the eight piezometer nests at the Winderl site. The chloride concentrations (mg/l) are the mean of the 1984 and 1985 analysis.

10,000 ohm-feet (304.8 to 3048 ohm-m) typical of sand and gravel units (Soiltest, 1968). Both the interpreted resistivity cross sections and the TDS plume map support the conclusion that contaminants have migrated beyond the limits of the study area (fig. 24) to the south and west to Spring Coulee Creek. A reduction in the contamination occurs to the southeast, but TDS values in this area are still above the recommended drinking water standard of 500 mg/l, and also above the TDS value reported as 1,700 mg/l, typical for glaciofluvial aquifers in the region (Randich and Kuzniar, 1984).

The areal extent of contamination to the north is not well defined due to the lithologic variations and associated problems with interpreting the resistivity survey, and also the lack of chemical data from the area. The highest concentration of contaminants detected within the sand and gravel unit was north of the disposal pit at 6p (TDS=20,335 mg/l). This well is located near the area where a second pit was constructed during the deepening of the well; the

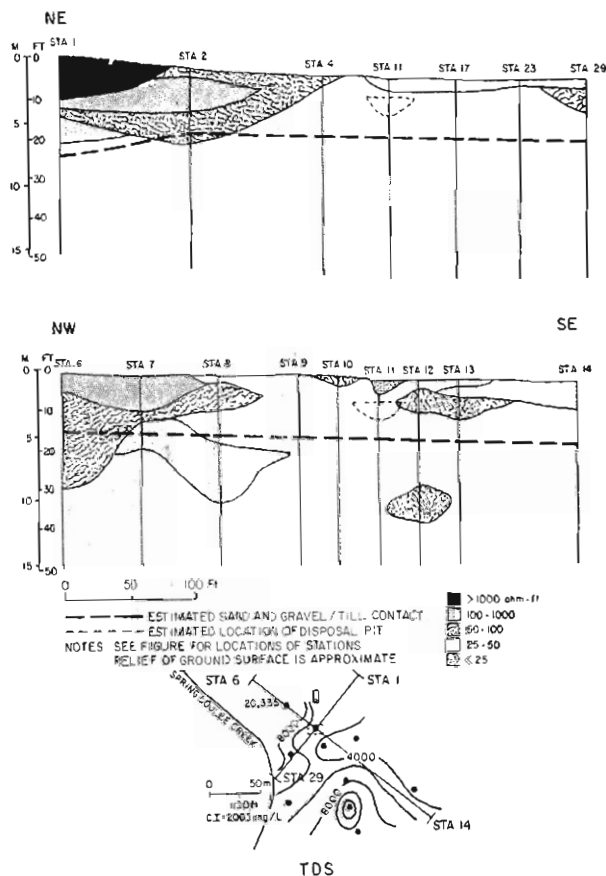

Figure 24. Northeast-southwest and northwest-southeast cross sections of Dar-Zarrouk interpreted resistivity and isoconcentration map of the Winderl site.

high concentrations could reflect contamination from this second pit. The situation is further complicated to the north by a disposal pit from another oil well located approximately 1,320 feet (402 m) north of the three background wells (1p-3p). The chloride concentrations detected in these wells exceed 6,000 mg/l, which is significantly greater than the typical concentrations for these glaciofluvial sediments. It is not clear whether these wells were contaminated from the disposal pit at the Winderl site, or the disposal pit to the north.

As discussed above, the high concentrations of contaminants detected in wells screened in till are thought to

reflect cross-contamination from the upper sand and gravel unit. Therefore, any interpretation of the vertical extent of contamination from the water chemistry data is subject to error. Also, density stratification of the contaminant has hampered any accurate qualitative interpretation of the horizontal distribution of contamination. The isoconcentration maps not only reflect the concentration of contaminants that have migrated horizontally, but also the depths and screen lengths of the wells.

The near surface low-resistivity layers complicate any interpretation of the vertical variations in resistivity that could indicate contamination with depth. The high conductivity of these layers causes the electric current, induced during the resistivity surveys, to travel horizontally rather than penetrate deeper as the A-spacing is increased. Therefore, the assumption that the electrode spacing is equal to the depth of current penetration is not valid.

Although the vertical extent of contamination could not be evaluated, boring data indicate that the sand and gravel unit (Spring Coulee Creek Aquifer) is the only aquifer identified within 50 feet (15.2 m) of the surface in the vicinity of the Winderl site. The major environmental concern is the extensive horizontal migration that has occurred within this unit.

Conclusions

Winderl Site

1. The drilling fluid leachate is characterized as predominantly chloride and sodium with lesser amounts of calcium, magnesium, sulfate, and potassium. The chemistry of the drilling fluid could not be obtained, but the NaCl content was estimated from log

headings to be between 40,000-100,000 ppm for the 1959 drilling mud. Trace metal concentrations were low in groundwater within the study area.

2. Leachate has migrated 400 feet (121.9 m) downgradient from the reserve pits within the Spring Coulee Creek Aquifer. An additional piezometer placed 1,400 feet (426.7 m) downgradient within this aquifer also indicated ion concentrations above the normal background levels. It has not been determined whether the source of the contaminant 1,400 feet (426.7 m) south of the Winderl site was from the Winderl lease or from other leases in the area.
3. A one-dimensional analytical solute transport analysis indicates high concentrations of contamination at the Winderl site up to 3,300 feet (1,000 m) downgradient from the disposal pit. The analytical solution is a simplified approach, although the analysis does suggest the potential for widespread solute migration within these glaciofluvial sediments.
4. Density stratification of the drilling fluid is thought to have occurred within the Spring Coulee Creek Aquifer. The highest concentrations were detected along the base of the sand and gravel unit.
5. The earth resistivity survey demonstrated that groundwater within the Spring Coulee Creek Aquifer in the study site was low in apparent resistivity and therefore correctly indicated that it had been contaminated.
6. Improper well construction allowed leachate to travel down the borehole and into the piezometers screened in till.

FOSSUM FEDERAL #4

Introduction

The Fossum Federal #4 well is situated in the Wiley Field on land owned by North Dakota State University (fig. 3). This well was selected because of its location and also because it is known to be underlain by a thick layer of till. It is also one of the few leases in this area that is surrounded by pasture and not cropland, which made access easier. Chevron, USA, Inc. drilled the well in 1978 to a depth of 4,200 feet (1,200 m). The well was treated with 1,500 gallons (5,700 L) of acid and produces from the Mission Canyon Formation (Mississippian). The brine chemistry is quite variable within the Mission Canyon Formation in this field (table 6). The buried reserve pit is unlined and was reclaimed by the trenching method. Drilling mud data were unavailable; however, the NaCl concentration was estimated from the electric logs at between 55,000 ppm and 130,000 ppm.

Geology

The ground surface at this site slopes gently upward to the north from the disposal pit (figs. 25, 26). The instrumentation was concentrated to the south of the disposal pit because groundwater was assumed to be flowing in the downslope direction. Background information was obtained from piezometers, pressure-vacuum lysimeters, and borings located approximately 450 feet (137 m) to the north of the pit (fig. 27).

The Fossum site is underlain by till interbedded with discontinuous sand lenses. A 3- to 5-foot (0.9-1.5 m) thick sand and gravel zone was encountered at a depth of 55-60 feet (16.8-18.3 m) throughout the study area (fig. 28). This zone may be a

Table 6. Chemical analyses of brines from the Madison Formation in the Wylie Field, Bottineau County. Data obtained from drill-stem tests.

| Temp | Res | pH | TDS (mg/l) | Ca (mg/l) | Mg (mg/l) | Na (mg/l) | Fe (mg/l) | Cl (mg/l) | CO ₃ (mg/l) | HCO ₃ (mg/l) | SO ₄ (mg/l) | |
|------|-----|-----|---------------|--------------|--------------|--------------|--------------|--------------|---------------------------|----------------------------|---------------------------|------|
| 68 | 55 | 7.0 | 203,519 | 3934 | 1020 | 72,914 | 0 | 122,000 | 0 | 195 | 2200 | |
| 68 | 52 | 6.8 | 214,018 | 3934 | 1190 | 77,111 | 0 | 129,000 | 0 | 98 | 1725 | |
| 68 | 61 | 6.4 | 193,017 | 3919 | 1187 | 69,526 | 0 | 115,420 | 0 | 162 | 2885 | |
| 68 | 91 | 6.1 | 112,719 | 2897 | 671 | 39,774 | 0 | 65,670 | 0 | 148 | 3634 | |
| 68 | 350 | 6.2 | 21,287 | 1348 | 302 | 6,141 | 0 | 10,250 | 0 | 425 | 3034 | |
| 68 | 180 | 5.8 | 45,087 | 2565 | 696 | 13,576 | 0 | 25,104 | 0 | 380 | 2959 | |
| 68 | 49 | 5.3 | 258,322 | 5510 | 1972 | 92,435 | 0 | 156,900 | 0 | 295 | 1360 | |
| 68 | 110 | 5.4 | 78,507 | 3325 | 870 | 25,605 | 0 | 45,501 | 0 | 220 | 3098 | |
| 68 | 52 | 5.3 | 216,405 | 2755 | 870 | 80,596 | 0 | 129,704 | 0 | 280 | 2369 | |
| 68 | 53 | 5.3 | 231,463 | 4940 | 1566 | 83,103 | 0 | 140,160 | 0 | 362 | 1516 | |
| 68 | 55 | 6.6 | 228,032 | 4763 | 1155 | 82,565 | 0 | 137,900 | 0 | 181 | 1560 | |
| 68 | 96 | 7.0 | 124,901 | 5715 | 2310 | 39,156 | 0 | 75,045 | 0 | 82 | 1835 | |
| 68 | 98 | 7.1 | 126,597 | 5334 | 2310 | 40,238 | 0 | 76,830 | 0 | 93 | 1839 | |
| 68 | 650 | 6.5 | 253,093 | 4572 | 1848 | 91,580 | 0 | 153,660 | 0 | 121 | 1374 | |
| 68 | 71 | 6.6 | 197,030 | 5334 | 1848 | 68,636 | 0 | 119,185 | 0 | 88 | 1984 | |
| 68 | 50 | 7.1 | 268,036 | 5130 | 1903 | 96,823 | 0 | 163,000 | 0 | 159 | 1102 | |
| 68 | 57 | 6.4 | 212,316 | 5148 | 1357 | 75,584 | 0 | 127,660 | 0 | 440 | 2350 | |
| 68 | 55 | 5.8 | 224,405 | 5148 | 1298 | 80,460 | 0 | 135,240 | 0 | 425 | 2050 | |
| HIGH | 68 | 650 | 7.1 | 268,036 | 5510 | 2310 | 96,823 | 0 | 163,000 | 0 | 440 | 3634 |
| LOW | 68 | 49 | 5.3 | 21,287 | 1348 | 302 | 6,141 | 0 | 10,250 | 0 | 82 | 1102 |
| MEAN | 68 | 93 | 6.3 | 182,414 | 4338 | 1298 | 64,535 | 0 | 109,686 | 0 | 227 | 2133 |

contact between two tills. Overlying the till is 2 to 4 feet (0.61 to 1.2 m) of finely laminated silts and clays (fig. 28). Moran and others (1985) have mapped these sediments as nearshore lacustrine deposits of Glacial Lake Souris (fig. 8). A near-surface sand unit is located to the north of the disposal pit where the ground surface slopes upward. The surficial sediment over much of the area is approximately 1 foot (0.3 m) of well-sorted silt, probably wind-blown sediment from nearby lacustrine deposits.

Textural analysis was performed on 11 till samples from the Fossum site. The textural-analysis results are illustrated in fig. 29. Most of the till is either loam or clay loam according to the United States Department of Agriculture classification. The pebbles within the till are carbonate and granitic rock fragments, with some dark-gray shale and lignite. Horizontal and vertical fractures were evident in the Shelby-tube samples from the

Fossum site. These fractures are thought to be ubiquitous in the tills of the Great Plains Region (Grisak and others, 1976).

The results of the X-ray-diffraction (XRD) analyses of clay samples from the till are presented in table 7. Peak heights on an X-ray diffractogram are an indication of the relative abundance of the different minerals; therefore, smectite is interpreted as the dominant clay. Further analysis of these clays with an energy-dispersive scanning electron microprobe determined that the smectite is predominantly a Ca-montmorillonite.

Geohydrology

Nested piezometers were installed at two different depths within the till, and the pressure-vacuum lysimeters were placed at various depths down to 19 feet (5.8 m) in and around the drilling-fluid disposal pit (fig. 27). The shallow piezometers were screened



Figure 25. The Fossum Federal #4 study site, Bottineau County. Photo taken looking north-northeast.



Figure 26. The Fossum Federal #4 study site, Bottineau County. Photo taken looking north-northeast.

from 35-45 feet (10.7-13.7 m) below the surface. The deep piezometers were installed at 60 feet (18.3 m) with 5-foot (1.5 m) screens. An initial boring was drilled at the site and allowed to remain open for approximately two days. The water level measured in this borehole was approximately 40 feet (12.2 m) below the surface. Accordingly, the upper piezometer in each nest was positioned to intersect this interval. However, water levels in these piezometers ranged from 3 to 9 feet (0.9 to 2.7 m) below the land surface during the monitoring period, indicating a much higher water table than previously anticipated. Because the vertical gradient in these nested piezometers is relatively low (≤ 0.009 ft/ft), the potentiometric values from the upper piezometers are used to depict the potentiometric surface of the till unit. Contour maps of these head values show radial flow away from the disposal area in October and December 1984, and radial flow away from a mound south of the disposal pit in May and June of 1985 (fig. 30).

At the Fossum site, rising and falling head tests were conducted on 12 piezometers screened within the till; the resulting hydraulic conductivity estimates range from 4.5×10^{-6} cm/s to 5.7×10^{-5} cm/s, with an average of 1.8×10^{-5} cm/s.

The hydraulic conductivity values obtained from these single-well response tests are considerably higher than the grain size indicates. Grisak and Cherry (1975) have estimated intergranular hydraulic conductivity from laboratory consolidation tests on 85 till samples across the Interior Plains Region. They obtained an average of 5×10^{-9} cm/s. The higher values from the slug tests in this study are attributed to secondary permeability from fractures, which is not reflected in laboratory consolidation tests. Evidence of the greater permeability along the fractures was observed in the Shelby-tube samples from the Fossum site. The oxidized zone extends approximately 2 feet (0.61 m) deeper along fracture surfaces than in the till matrix, which is an indication that

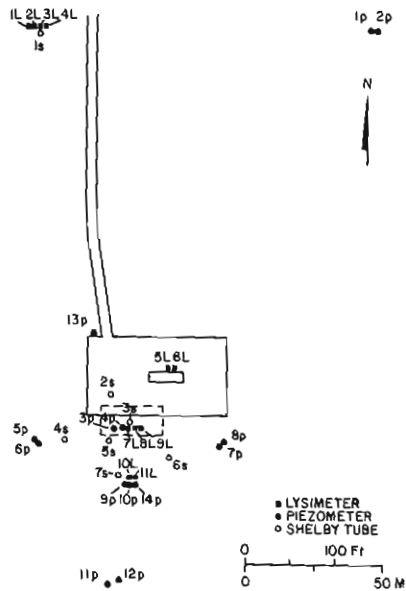

Figure 27. Map view of the Fossum site depicting groundwater and porewater instrumentation and Shelby-tube hole locations.

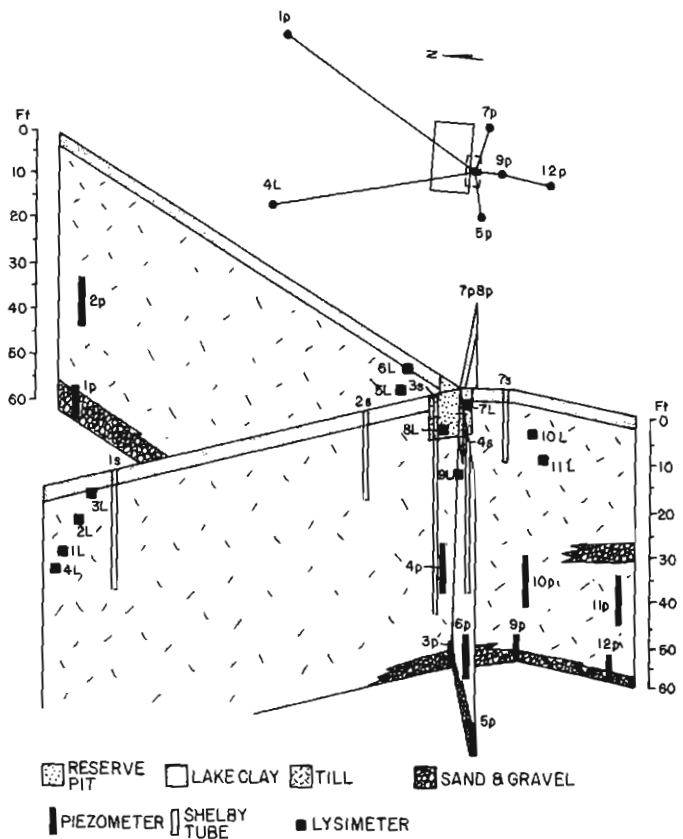

Figure 28. Geologic fence diagram of the Fossum study site.

downward percolating water is moving faster along these fractures.

Buried drilling fluid was encountered between 5-12.5 feet (1.5-3.8 m) below the surface at this site. The base of the old pit was found at 10-12 feet (3.05-3.7 m) and the bottom of the trenches went down to 15 feet (4.6 m). Therefore, the majority of drilling mud at this site is buried below the water table.

Apparent Resistivity

A surface resistivity survey was run at the Fossum lease. The survey consisted of 25 resistivity stations. Readings were taken at successive electrode spacings of 3, 5, 8, 10, 12,

16, 20, 24, 30, 40, 50, 60, 80, and 100 feet (0.9, 1.5, 2.4, 3.1, 3.7, 4.9, 6.1, 7.3, 9.1, 12.2, 15.2, 18.3, 24.4, and 30.5 m).

Apparent iso-resistivity maps were constructed for the electrode spacings up to 30 feet (9.1 m) (fig. 31). Readings could not be obtained from many of the stations at electrode spacings greater than 30 feet (9.1 m). Therefore, we did not have sufficient data to generate maps for these deep electrode spacings.

The iso-resistivity maps all depict an area (approximately 100 x 200 feet {30.5 x 61 m}) of extremely low resistivity (≤ 20 ohm-ft) that extends to the east and southeast from the buried drilling fluid. The resistivity

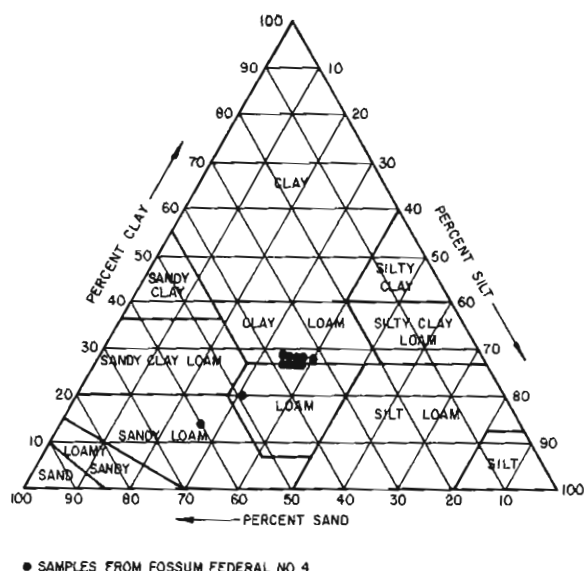

Figure 29. United States Department of Agriculture textural classification of the till samples from the Fossum site.

values increase radially away from the buried mud to highs of: 200-300 ohm-feet, for electrode spacings of 3-8 feet (0.9-2.4 m), 90-140 ohm-feet, for spacings of 10-20 feet (3.1-6.1 m), and approximately 50 ohm-feet, for spacings of 24-50 feet (7.3-15.2 m) (fig. 31).

The resistivity survey was of limited value at the Fossum site. Several of the resistivity soundings in the vicinity of the disposal pit could be conducted only for the smaller electrode spacings due to the extremely low resistivity values detected near the surface. The problems with the resistivity survey at the Fossum site are thought to result from physical obstructions in the area. Electrical lines and pipelines are known to exist throughout the subsurface. These obstructions will interfere with the electrical current and cause anomalous resistivity readings. The apparent resistivity values could not be interpreted by the Dar Zarrouk analysis for the resistivity stations near the disposal area. Consequently, interpreted resistivity cross sections were not

constructed.

The low resistivity area, indicating contamination, is centered around the disposal pit and slightly skewed to the south. Resistivity increases with distance from the disposal area in all directions. The high resistivity values to the north probably reflect the near-surface sand layer in that area.

Groundwater Chemistry

Water samples were collected from the twelve wells at the Fossum site. Eight of the eleven pressure-vacuum lysimeters yielded a total of twelve samples (during the 1984-1985 period for a success rate of 55 percent.) Because the water table at the site is higher than was estimated during installation of the monitoring equipment, several of these lysimeter samples were collected from the saturated zone.

Isoconcentration maps were constructed from the mean of the 1984 and 1985 groundwater samples for the shallow (45-foot {13.7 m}) and deep (60-foot {18.3m}) piezometers (figs. 32, 33). The maps show a leachate plume extends south from the buried drilling fluid in an area approximately 100 x 150 feet (30.5 x 45.7 m). The ion concentrations were generally 1.5 to 2 times higher in groundwater within the shallow piezometers as compared to the deeper zone (figs. 32, 33).

The highest concentration reported for lead was 23 $\mu\text{g/l}$ and 20 $\mu\text{g/l}$ was the highest concentration reported for chromium. These data are not discussed further because of the lack of confidence in the trace metal analyses, as discussed in the groundwater section of the Winderl site.

The highest concentration detected in the water samples came from a lysimeter buried within drilling mud at a depth of 14 feet (4.3 m) (i.e., TDS of 131,180 mg/l and 74,177 mg/l of chloride). The concentrations of these

Table 7. X-ray-diffraction analyses of clay samples from till at the Fossum site.

| Hole No. | Depth (feet) | Smectite [001] | Chlorite [001] | Muscovite [001] Illite [001] | Kaolinite [001] Chlorite [002] |
|-------------------|--------------|-----------------------|----------------|---------------------------------|-----------------------------------|
| <u>Air-Dried</u> | | Peak Heights (inches) | | | |
| 5s | 10 | 4.6 | --- | 3.2 | 2.3 |
| 5s | 20 | 23.0 | 9.0 | 13.0 | 14.0 |
| 5s | 40 | 19.6 | --- | 4.0 | 15.0 |
| <u>Glycolated</u> | | | | | |
| 5s | 10 | 16.0 | --- | 2.8 | 3.0 |
| 5s | 20 | 51.0 | --- | 10.8 | 12.8 |
| 5s | 40 | 51.0 | --- | 7.4 | 11.8 |

ions at a depth of 45 feet (13.7 m) below the base of the buried drilling mud were 7,342 mg/l of TDS and 2,203 mg/l of chloride (fig. 33). These values are well above background levels.

Chemical profiles of this site (fig. 34) support the conclusion drawn from the isoconcentration maps. A comparison of the upgradient and downgradient profiles demonstrate that leachate has extended beyond the 9p piezometer. The chemical profiles indicate that contaminants are migrating radially away from the disposal area at a depth close to the water table. Two additional piezometers (13p and 14p) were installed at the site during November 1986. The upgradient piezometer (13p) was installed at a depth of 22 feet (6.7 m) with a 4-foot (1.2 m) screen. A water sample from this piezometer collected in December 1986 contained 10,500 mg/l of TDS and 73 mg/l of chloride. The low chloride ion concentration indicates that there is little or no migration of drilling fluid leachate to the north (upgradient) at the site.

Piezometer 14p was installed adjacent to piezometers (11p-12p) and at a depth of 17 feet (5.2 m) with a 4-

foot (1.2) screen. A December 1986 water sample from this piezometer indicated 24,500 mg/l of TDS and 14,900 mg/l of chloride. These are the highest concentrations that have been detected outside of the Fossum reserve pit in either porewater or groundwater. For comparison, an adjacent lysimeter (11L), at a depth of 14 feet (4.3 m), contained 1,678 mg/l of chloride when sampled in October of 1984. The increase in chloride concentration at this depth could indicate a significant increase in leachate migration over this two-year period. Another possibility is that the contaminants are dominantly migrating in the zone where piezometer 14p is installed, and the bulk of contaminant migration was not detected in the 1984 sampling period.

Saturated-Paste Extract

Information on the soil-water chemistry of selected sediment samples was obtained by saturated-paste extract analyses. A total of 21 Shelby-tube samples from the Fossum site was analyzed. These samples were collected at depths ranging from 5 feet (1.5 m)

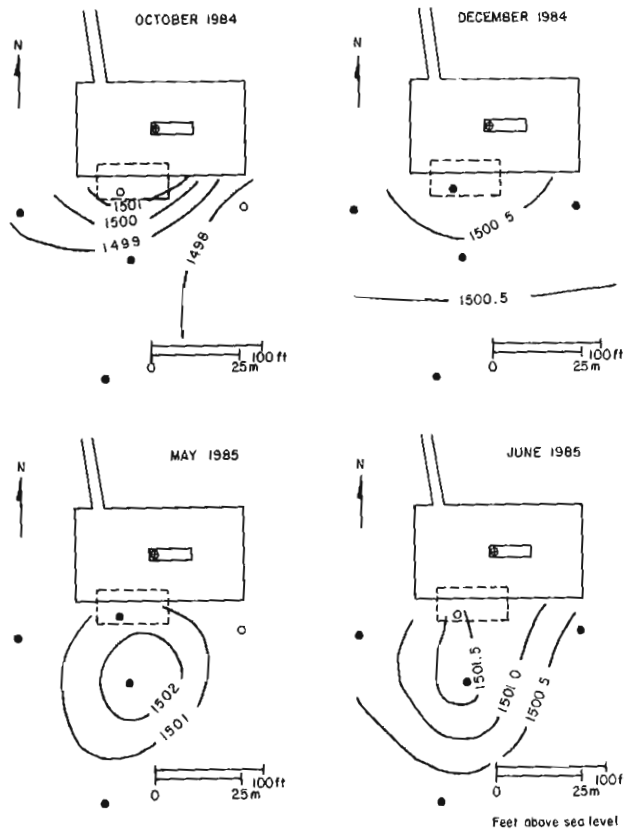

Figure 30. Potentiometric maps of the till unit at the Possum site (October, 1984 to June, 1985).

to 30 feet (9.1 m) below the surface.

The saturated-paste extract analyses from the Fossum site are plotted on vertical distribution diagrams for six parameters: electrical conductivity, chloride, sodium, calcium, magnesium, and sulfate (fig. 35). In general, there is an abrupt decrease in contamination with depth. Boring 3s was drilled directly through the disposal pit and the chloride concentration ranged from a maximum of 1,111 mg/l at a depth of 10 feet (3.0 m) to 2.54 mg/l at a depth of 20 feet (6.1 m). There is a similar vertical relationship for the other parameters.

Laterally, the concentrations of the contaminants decrease with distance from the buried disposal pit. The maximum chloride concentration detected beyond 60 feet (18.3 m) of the

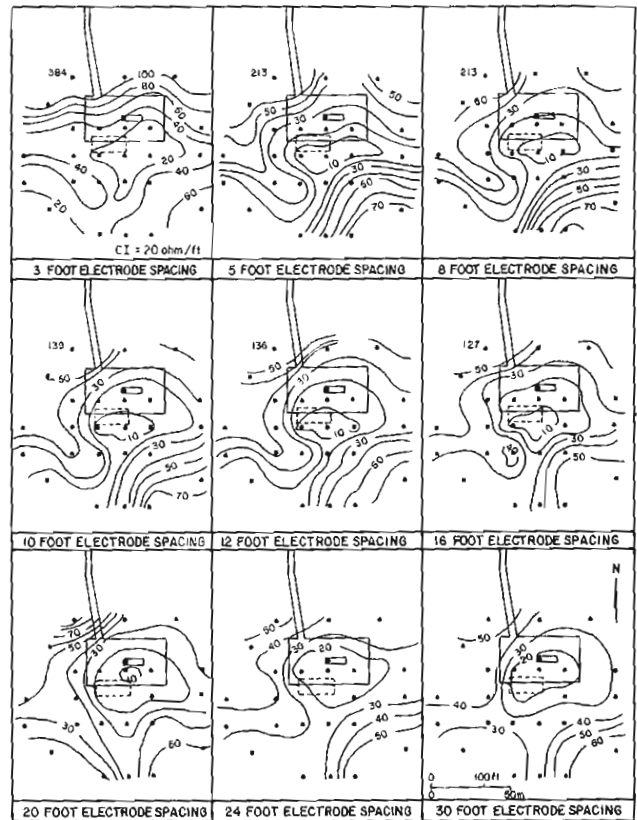

Figure 31. Apparent isoresistivity maps of the Fossum site at electrode spacings of 3, 5, 8, 10, 12, 16, 20, 24, and 30 feet (0.9, 1.5, 2.4, 3.1, 3.7, 4.9, 6.1, 7.3, and 9.1 m). Unless noted otherwise, CI = 10 ohm/ft.

disposal pit was 122 mg/l at 7s. Sulfate is an exception to this trend. The highest sulfate concentration detected in the saturated-paste extract samples (130 mg/l) was approximately 40 feet (12.2 m) northwest of the disposal pit at 2s. A cross section of chloride concentration with depth was constructed from the soluble extract data (fig. 36) to illustrate the distribution of contamination in the sediment. This data demonstrates that the majority of drilling fluid leachate is confined to the top 20 feet (6.1 m). Figure 36 further indicates that the contaminants have migrated horizontally in the sediment beyond the limits of the saturated-paste extract data. Nevertheless, the

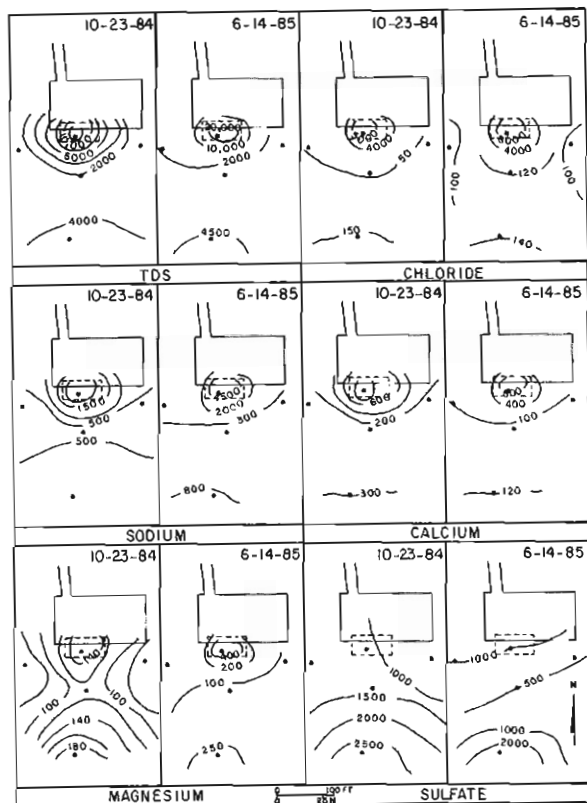

Figure 32. Isoconcentration maps of TDS, Cl, Na, Ca, Mg, and SO_4 from groundwater at a depth of 35-45 feet (10.7-13.7 m) below the surface at the Fossum site (mg/l).

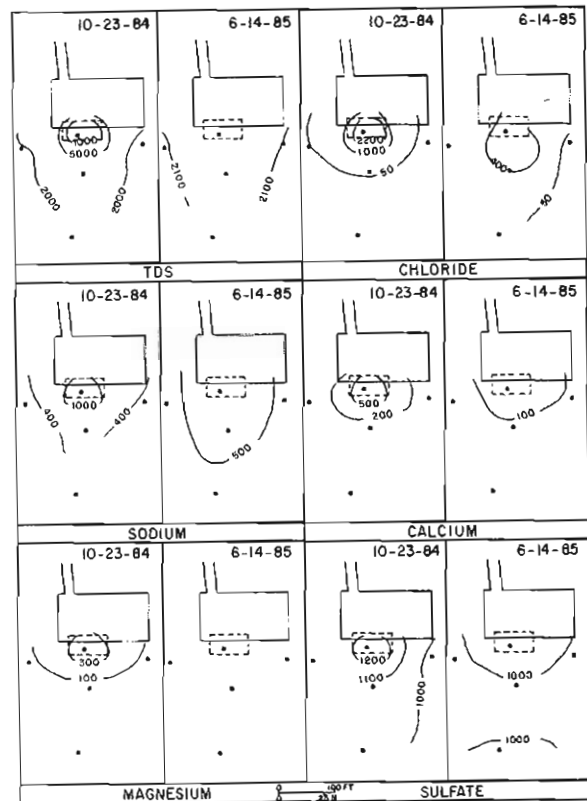

Figure 33. Isoconcentration maps of TDS, Cl, Na, Ca, Mg, and SO_4 from groundwater at a depth of 60 feet (18.3 m) below the surface at the Fossum site (mg/l).

saturated-paste extract results illustrate a significant reduction in contaminants laterally from the disposal pit.

Contaminant Migration in Till

The lithologic and hydrologic data from the Fossum site indicate that fractures in the till cause permeabilities several orders of magnitude greater than is indicated by the grain size of the till matrix (fig. 37). As a result, the groundwater flow velocity through these fractures is orders of magnitude greater than the velocity through the till matrix. The average linear velocity is determined by dividing the specific discharge (the hydraulic conductivity times the gradient) by the porosity (the fracture porosity is much less

than the intergranular porosity). Grisak (1975) suggests values for fracture porosity on the order of 2×10^{-4} . With an average hydraulic conductivity from the Fossum site of 1.8×10^{-5} cm/s, a gradient of 0.05 (obtained from the October 1984 potentiometric map), and a fracture porosity of 2×10^{-4} , the average linear velocity along the fractures is 3.8 m/day (12.8 ft/day). The intergranular velocity calculated with the same gradient, an effective porosity of 0.10 and a hydraulic conductivity of 5.0×10^{-9} cm/s (suggested by Grisak and Cherry {1975}), is 2.5×10^{-7} m/day (8.2 $\times 10^{-6}$ ft/day). Although the groundwater velocity along the fractures is high, the quantity (or flux) of water is low

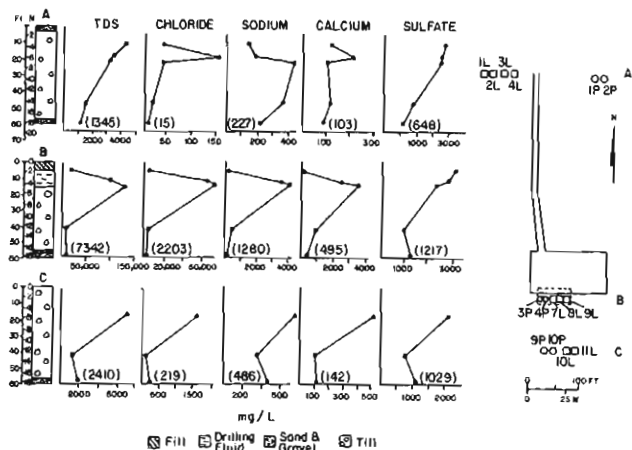

Figure 34. Chemical ion profiles for three lysimeter and piezometer nests (A, B, and C) at the Fossum site.

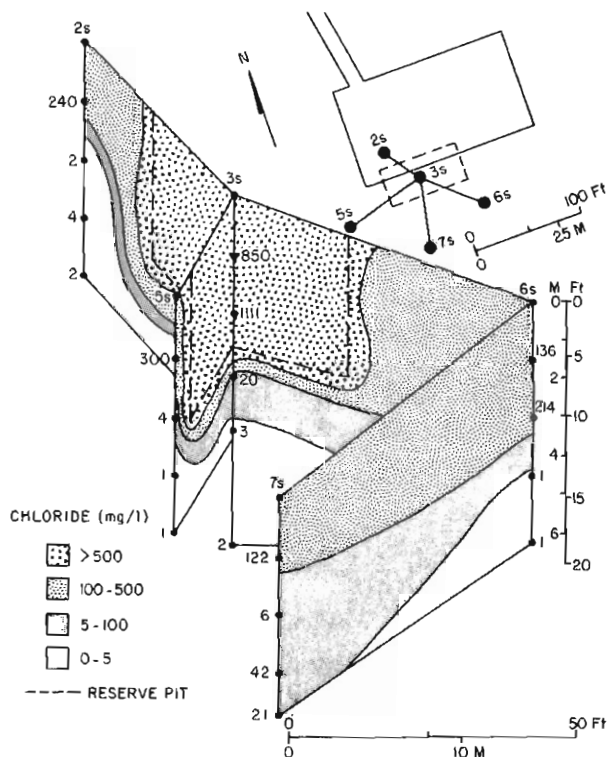

Figure 36. A fence diagram of chloride concentrations obtained from saturated-paste extracts at the Fossum site.

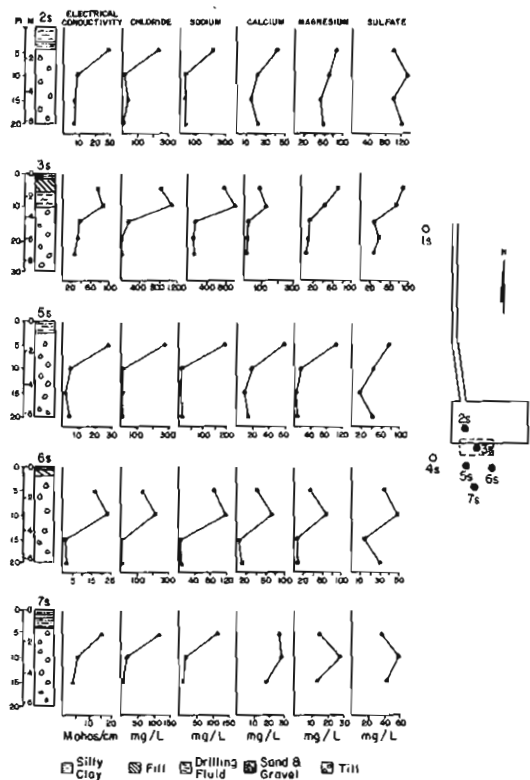

Figure 35. Electrical conductivity and ion profiles from saturated-paste extract data obtained from Shelby-tube sediments at the Fossum site.

due to the small volume of pore space these fractures constitute.

Several studies have been conducted on the migration of contaminants through fractured till. Experiments by Grisak and others (1980) demonstrated that diffusion in the till matrix is an important retardation mechanism. As the solute migrates along the fractures, solute concentration gradients between the groundwater in the fractures and the till matrix cause diffusion of these solutes into the matrix, and the low intergranular velocity in the matrix prevents any further significant migration. The retardation of contaminants migrating in the fractures, accompanied by the relatively low flux of water associated with fracture permeability, limits the potential for contaminant migration in the fractured tills.



Figure 37. Performing falling head tests at the Fossum #4. Willie Real "cooling down" (-2° F) between readings (January 4, 1985).

Conclusions

Fossum Federal #4

1. The drilling fluid leachate is characterized as predominantly chloride and sodium with lesser amounts of calcium, magnesium, sulfate, and potassium. The NaCl content of the drilling fluid was estimated from the electric logs at between 55,000 and 130,000 ppm.
2. The majority of drilling mud at this site is buried below the water table.
3. The earth resistivity surveys delineated an area of low resistivity (20 ohm-ft) which extends outward from the pit with an areal extent of approximately 100 x 200 feet (30.5 x 61 m).
4. Fractures in the till cause permeabilities several orders of

magnitude greater than is indicated by the grain size or the till matrix. The groundwater velocity through these fractures is estimated at 12.8 feet/day (3.9 m/day). Molecular diffusion within the tills, however, is an important retardation mechanism that reduces the concentration of the contaminants along the fractures with distance from the source.

5. Leachate has migrated out of the buried drilling fluid resulting in contamination that extends laterally over an area of approximately 100 x 150 feet (30.5 x 45.7 m). Contamination was detected in the groundwater at a depth of 60 feet below the disposal pits.
6. Saturated-paste extract data and groundwater and porewater samples indicate that the majority of the contamination has migrated laterally in the zone directly below the water table.

RECOMMENDATIONS

Disposal of drilling fluids in glaciofluvial sediments in north-central North Dakota is not recommended. At the Winderl site, disposal in a glaciofluvial meltwater channel has resulted in widespread contamination and degradation of the Spring Coulee Creek Aquifer. Even if these pits are lined, fluid is pushed into unlined trenches during reclamation, which allows for infiltration through these permeable sediments.

Murphy and Kehew (1984) suggest a reclamation procedure in which a synthetic liner is utilized to contain the drilling fluid, and compacted fill is mounded over the disposal pits to

prevent leachate generation. In north-central North Dakota, however, the water table is close to the surface, and portions of the disposal pits are commonly in the saturated zone. Leachate would be generated by either vertical infiltration or horizontal flow through the buried disposal pits. Containment of this leachate would be dependent solely upon the integrity of the synthetic liner and careful disposal techniques that prevent movement of groundwater through the disposal pits. Because of the difficulties of ensuring proper disposal and the potential for widespread contaminant migration in these glaciofluvial sediments, this disposal method is also not recommended.

The environmental impact from disposal of drilling muds in till is dependent upon the geologic setting. Results from the Fossum site investigation indicate that contaminant migration will occur in these tills through fractures. However, the contaminants are attenuated within a relatively short distance from the disposal pits. Nevertheless, numerous sand lenses were encountered within the till. These permeable lenses could provide avenues for migration of contaminants to nearby aquifers. A subsurface investigation should be conducted at each disposal site to identify all permeable strata in the areas and locate any nearby aquifers.

Since 1984, some local operators have been transporting the drilling muds off site to central disposal sites located in western North Dakota. These sites are under the jurisdiction of the North Dakota State Department of Health's Division of Waste Management and Special Studies. The chemical analyses of the drilling mud must be provided to this agency for approval prior to disposal at this site. There are currently three central disposal sites operating in North Dakota (Tillotson, 1987).

The advantage of consolidation of this waste is that the number of disposal areas is decreased, which allows for more efficient regulation. However, a major aspect that reduces the potential for more environmental problems resulting from drilling fluid disposal is the relatively low volume of waste associated with the drilling fluid reserve pits. The consolidation of these wastes will increase the potential for adverse environmental impact problems if improper disposal techniques are utilized. The state of North Dakota should carefully regulate these centralized disposal areas and require groundwater monitoring to ensure that leachate migration does not occur.

PRESENT STATUS OF DRILLING FLUID DISPOSAL IN NORTH DAKOTA

There are a number of methods of drilling fluid disposal that are being used throughout the oil producing regions of the United States (table 8). However, in the majority of cases, drilling fluid is buried on site. This is the cheapest (approx. \$14,000.00) and fastest method of reclamation, although not always environmentally acceptable (EPA, 1986).

The high chloride concentrations of Williston Basin drilling fluid make land farming impossible and chemical treatment difficult and expensive. Annular injection is difficult due to the high viscosity of the drilling fluid and can only be used in abandoned wells (table 8).

The majority of reserve pits in North Dakota are reclaimed by the trenching method, i.e., a series of unlined trenches are constructed from the pit and the drilling fluid is pushed into them. This method is used regardless of whether the pit is lined or not. It is no longer an acceptable

Table 8. Methods of drilling fluid disposal.

| DRILLING FLUIDS DISPOSAL METHODS | |
|----------------------------------|--|
| <u>ON SITE</u> | |
| 1) BURIAL | (Most common costs average around \$4,000/blt) |
| A) | Chemical fixation |
| B) | Solidification |
| 2) ENCAPSULATION | (Alabama, Michigan and Utah) |
| 3) TRENCHING | (Phased out in Michigan) |
| 4) ANNULAR INJECTION | (Only used where well is to be abandoned) |
| <u>OFF SITE</u> | |
| 1) LANDFARMING | (Have to have low Cl ⁻ , widespread in Texas, Colorado and Louisiana) |
| 2) INCINERATION | |
| 3) CENTRAL TREATMENT FACILITY | |
| 4) CENTRAL DISPOSAL SITE | (2 in North Dakota, 95 in Oklahoma) |

Source: EPA, 1986

method of pit reclamation in Michigan, and it is the authors' opinion that it should be phased out in North Dakota.

The results of this study and the previous work by Murphy and Kehew (1984) demonstrate that drilling mud can be buried on site at the majority of oil and gas wells in North Dakota without creating a major impact on the groundwater. The drilling fluid should be encapsulated and the site mounded to minimize leachate generation.

There are a small percentage (note, however, that 10 percent of 11,000 is 1,100 sites) of the total number of wells in North Dakota that are situated within environmentally sensitive areas, i.e., floodplains and glaciofluvial channels. In such settings, the drilling fluid should be removed to a central disposal site.

REFERENCES

- Anderson, M. P., 1984, Movement of contaminants in groundwater: groundwater transport-advection dispersion: in *Groundwater Contamination: National Academy Press, Washington, DC, p. 37-44.*
- Anderson, S. B., 1987, personal communication, Acting State Geologist, North Dakota Geological Survey, Grand Forks, North Dakota, March 12.
- Anderson, S. B., Bluemle, J. P., 1984, Oil exploration and development in the North Dakota Williston Basin-1983 update: North Dakota Geological Survey Miscellaneous Series 65, 34 p.
- Beal, W. A., 1986, Contaminant migration of oil-and-gas drilling fluids within the glaciated sediments of north-central North Dakota, University of North Dakota unpublished Masters thesis, 242 p.
- Blatt, H., Middleton, G., and Murray, R., 1972, *Origin of sedimentary rocks*, Prentice-Hall, Inc., Englewood Cliffs, New Jersey, 634 p.
- Bluemle, J. P., compiler, 1971, Depth to bedrock preliminary map: North Dakota Geological Survey Miscellaneous Map 13, scale 1:500,000.
- Bluemle, J. P., 1983, Geologic and topographic bedrock map of North Dakota: North Dakota Geological Survey Miscellaneous Map 25, scale 1:670,000.
- Bluemle, J. P., 1985, Geology of Bottineau County, North Dakota: North Dakota Geological Survey Bulletin 78, Part I (North Dakota State Water Commission County Groundwater Studies 35), in press.
- Borchert, R. N., 1987, personal communication, Geologist, Harris, Brown, and Klemer, Bismarck, North Dakota, March 12.
- Cartwright, Keron, and McComas, M. R., 1968, Geophysical surveys in the vicinity of sanitary landfills in north-eastern Illinois: *Groundwater*, v. 6, p. 23-30.
- Cherry, J. A., Gillham, R. W., and Balker, J. F., 1984, Contaminants in groundwater: in *Groundwater Contamination: National Academy Press, Washington, DC, p. 46-64.*
- Clayton, Lee, Moran, S. R., and Bluemle, J. P., 1980a, Explanatory text to accompany the geologic map of North Dakota: North Dakota Geological Survey Report of Investigation 69, 93 p.
- Clayton, Lee, Moran, S. R., and Bluemle, J. P., and Carlson, C. G., 1980b, Geologic map of North Dakota: U.S. Geological Survey, scale 1:670,000.
- Dames and Moore, 1982, Analysis of hydrologic and environmental effects of drilling mud pits and produced water impoundments: Volume I-Executive summary and report: American Petroleum Institute, 109 p.
- Dewey, M. B., 1984, Effect of reserve pit reclamation on groundwater quality at selected oil well sites in eastern Montana and western North Dakota: University of Montana M.S. thesis, Missoula, 174 p.
- Drever, J. I., 1982, *The geochemistry of natural waters*, Prentice-Hall, Inc. Englewood Cliffs, New Jersey, 388 p.
- Fischer, D. W., and Bluemle, J. P., 1986, Oil exploration and

- development in the North Dakota Williston Basin: 1984-1985 update, North Dakota Geological Survey Miscellaneous Series 67, 40 p.
- Fisher, Farley, project director, 1975, Conference on the environmental aspects of chemical use in well drilling, Houston, Texas, May, 1975, Proceedings: U.S. Environmental Protection Agency, EPA-560/1-75-004, 604 p.
- Freeze, R. A., and Cherry, J. A., 1979, Groundwater: Prentice-Hall, Inc.: Englewood Cliffs, New Jersey, 604 p.
- Gatlin, Carl, 1960, Petroleum Engineering--Drilling and Well Completion: Englewood Cliffs, New Jersey, Prentice-Hall, Inc., 341 p.
- Gerhard, L. C., and Anderson, S. B., 1981, Oil exploration and development in the North Dakota Williston Basin-1980 update: North Dakota Geological Survey Miscellaneous Series 59, 19 p.
- Greenhouse, J. P., and Harris, R. D., 1983, Migration of contaminants in groundwater at a landfill: a case study, 7. DC, VLF, an inductive resistivity surveys, Journal of Hydrology, v. 63, p. 177-198.
- Griffin, R. A., Cartwright, Keros, Shimp, N. F., Steele, J. D., Ruch, R. R., White, W. A., Hughes, G. M., and Gilkeson, R. H., 1976, Attenuation of pollutants in municipal landfill leachate by clay minerals: Part I-Column leaching and field verification: Illinois State Geological Survey Environmental Geology Notes 78, 34 p.
- Grisak, G. E., and Cherry, J. A., 1975, Hydrologic characteristics response of fractured till and clay confining a shallow aquifer: Canadian Geotechnical Journal, v. 12, p. 304-343.
- Grisak, G. E., Pickens, J. A., Vonhof, J. A., and Bluemle, J. P., 1976, Hydrogeologic and hydrogeochemical properties of fractured till in the interior plains region in Legget, R. F. (editor), Glacial Till: Royal Society of Canada Special Publication 12, Ottawa, p. 304-335.
- Grisak, G. E., Pickens, J. F., and Cherry, J. A., 1980, Solute transport through fractured media, 2 column study of fractured till: Water Resources Research, v. 16, no. 4, p. 731-739.
- Horsley, M. J., 1951, Time lag and soil permeability in groundwater observations: Waterways Experiment Station, Corps of Engineers, U.S. Army Bulletin 36, Vicksburg, Mississippi, 147 p.
- Javandel, I., Doughty, C., and Tsang, C. F., 1984, Groundwater transport: Handbook of mathematical models, American Geophysical Union, Washington, DC, 228 p.
- Jenne, E. A., 1968, Control of Mn, Fe, Ni, Cu, and Zn concentration in soils and waters: Significant role of hydrous Mn and Fe oxides. Trace inorganics in water, American Chemical Society Publication 73, p. 475-488.
- Jensen, R. E., 1972, Climate in North Dakota: Fargo, North Dakota, North Dakota State University, 48 p.
- Kehew, A. E., and Clayton, Lee, 1980, Late Wisconsinan catastrophic floods and the development of the Souris Pembina spillway system: in Teller, J. T., and Clayton, Lee (editors), Glacial Lake Agassiz:

- Geological Association of Canada
Special Paper 26, p. 187-209.
- Krauskopf, K. B., 1979, Introduction to geochemistry (2nd ed.): New York, McGraw-Hill, 617 p.
- Moran, S. R., Harris, K. L., Deal, D. E., and Bluemle, J. P., 1985, Geologic map of Bottineau County, North Dakota, scale 1:127,000, in Bluemle, J. P., Geology of Bottineau County, North Dakota: North Dakota Geological Survey Bulletin 78, Part I (North Dakota State Water Commission County Groundwater Studies 35) Plate 1, in press.
- Mosely, H. R., 1983, Summary and analysis of American Petroleum Institute onshore drilling mud and produced water environmental studies: American Petroleum Institute, 75 p.
- Murphy, E. C., 1983, The effect of oil and gas well drilling on shallow groundwater in western North Dakota: University of North Dakota M.S. thesis, Grand Forks, North Dakota, 242 p.
- Murphy, E. C., and Kehew, A. E., 1984, The effect of oil and gas well drilling on shallow groundwater in western North Dakota: North Dakota Geological Survey Report of Investigation 82, 156 p.
- Musser, David, 1985, In-place solidification of oil field drilling fluids, in proceedings of a national conference on disposal of drilling wastes, May 30-31, University of Oklahoma, Norman, Oklahoma, p. 67-72.
- Pettyjohn, W. A., and Hutchinson, R. D., 1977, Groundwater resources of Renville and Ward counties, North Dakota: North Dakota Geological Survey Bulletin 55, Part III (North Dakota State Water Commission County Ground-water Studies 35), 41 p.
- Randich, P. G., and Kuzniar, R. L., 1984, Ground-water resources of Bottineau and Rolette counties, North Dakota: North Dakota Geological Survey Bulletin 78, Part III (North Dakota State Water Commission County Ground-water Studies 35), 41 p.
- Reed, P. C., Cartwright, K., and Osby, D., 1981, Electrical resistivity surveys near brine holding ponds in Illinois: Illinois State Geological Survey Geology Notes 95, 30 p.
- Reetz, Rod, 1987, written communication, Assistant Director, Division of Chemistry Laboratory, North Dakota State Department of Health, Bismarck, North Dakota, March 13.
- Reiten, J. C., 1987, personal communication, Hydrologist, Montana Bureau of Mines and Geology, Billings, Montana, March 17.
- Sandoval, F. M., and Power, J. F., 1977, "Laboratory Methods Recommended for Chemical Analysis of Mined-land Spoils and Overburden in Western United States": U.S. Department of Agriculture, Agriculture Handbook 525, 31 p.
- Schlumberger Well Surveying Corporation, 1978, Log interpretation charts, Houston, Texas, 83 p.
- Simpson, J. P., 1975, Drilling fluid principles and operations: in Fisher, Farley, project director, Conference on the Environmental Aspects of Chemical Use in Well Drilling, Houston, Texas, May, 1975, Proceedings: U.S. Environmental

Protection Agency, EPA-560/1-75-004, p. 61-71.

Soiltest Inc., 1968, Earth resistivity manual: Evanston, Illinois, Soiltest Inc., 52 p.

Stevenson, R. J., 1985, personal communication, Director of the Natural Materials Analytical Laboratory, University of North Dakota, Grand Forks, North Dakota, April 10.

Tillotson, Stephen, 1987, personal communication, Environmental Scientist, North Dakota State

Department of Health-Division of Hazardous Waste Management, April 13.

Zhody, A. R., 1975, Automatic interpretation of Schlumberger sounding curves using modified Dar Zarrouk functions: U.S. Geological Survey Bulletin 1313-E, 39 p.

Zhody, A. R., and Bisdorf, R. J., 1975, Computer program for the forward calculation and automatic inversion of Wenner sounding curves: U.S. Department of Commerce National Technical Information Service publication PB-247, 47 p.

The Appendices were not printed in this volume as a means of reducing the final cost. Please contact the North Dakota Geological Survey if you would like a copy. North Dakota Geological Survey
University Station
Grand Forks, North Dakota 58202-8156
(701) 777-2231